

# REOTEMP Instrument Corporation

10656 Roselle Street San Diego, CA 92121 (800) 648-7737 FAX: (858) 784-0720

WebSite: <http://www.reotemp.com> E-mail: [sales@reotemp.com](mailto:sales@reotemp.com)

## SERIES DM - 1/8 DIN UNIVERSAL DC INPUT PANEL METER



- EASY STEP BY STEP INSTRUCTIONS
- OPTIONAL CUSTOM UNITS OVERLAY W/ BACKLIGHT
- FOUR VOLTAGE RANGES (300 VDC Max)
- FIVE CURRENT RANGES (2A DC Max)
- THREE RESISTANCE RANGES (10K Ohm Max)
- SELECTABLE 24 V, 2 V, 1.75 mA EXCITATION
- 16 POINT SCALING FOR NON-LINEAR PROCESSES
- PROGRAMMABLE FUNCTION KEYS / USER INPUTS
- FOUR SETPOINT ALARM OUTPUTS (W/Plug-in card)
- COMMUNICATION AND BUS CAPABILITIES (W/Plug-in card)
- ANALOG OUTPUT SIGNAL (W/Plug-in card)
- PC SOFTWARE AVAILABLE FOR METER CONFIGURATION
- NEMA 4X/IP65 SEALED FRONT BEZEL
- 9 DIGIT TOTALIZER (INTEGRATOR) WITH BATCHING

### GENERAL DESCRIPTION

The Series DM - Universal DC Input Meter offers many features and performance capabilities to suit a wide range of industrial applications. The meter employs advanced technology for stable, drift free readout, while incorporating features that provide flexibility now and in the future with plug-in option cards. The plug-in card options allow the opportunity to configure the meter for present applications, while providing easy upgrades for future needs.

The PAXD Universal Meter has four voltage inputs (300 VDC max), five current inputs (2 A DC max), and three resistance inputs (10 KΩ max). Selectable excitation of 24 V, 2 V reference and 1.75 mA reference provides power to transmitters and potentiometers. A 16-point input scaling feature compensates for non-linear processes.

The meter provides a Max and Min reading memory with programmable capture time. The capture time is used to prevent detection of false max and min readings which may occur during start-up or unusual process events.

The signal totalizer (integrator) can be used to compute a time-input product. This can be used to provide a readout of totalized flow, calculate service intervals of motors and pumps, etc. The totalizer can also accumulate batch weighing operations.

The meter has four setpoint outputs, implemented on Plug-in cards. The Plug-in cards provide dual FORM-C relays (5 A), quad FORM-A relays (3 A) or either quad sinking or quad sourcing open collector logic outputs. The setpoint alarms can be configured in modes to suit a variety of control and alarm requirements.

- High and low absolute, high and low deviation and band acting
- Balanced or unbalanced hysteresis
- On and off delay timers
- Auto reset or latching modes
- Reverse phase output and/or panel indicator
- Selection of alternate list of setpoint values

Plug-in cards also facilitate bus communications. These include RS232, RS485 and Modbus. Readout values and setpoint alarm values can be controlled through the bus. Additionally, the meter has features that allow a remote computer to directly control the outputs of the meter. With a communication card installed, it is possible to configure the meter using a Windows based program. The configuration data can be saved to a file for later recall.

A linear DC output signal is available as a Plug-in card. The card provides either 20 mA or 10 V signals. The output can be scaled independent of the input range.

The features of the linear output cards are:

- Output tracks either input, totalizer, max or min readings
- Programmable output update times

Once the meter has been initially configured, the parameter list may be locked out from further modification in its entirety or only the setpoint values can be made accessible.

The meter has been specifically designed for harsh industrial environments. With NEMA 4X/IP65 sealed bezel and extensive testing of noise effects to CE requirements, the meter provides a tough yet reliable application solution.

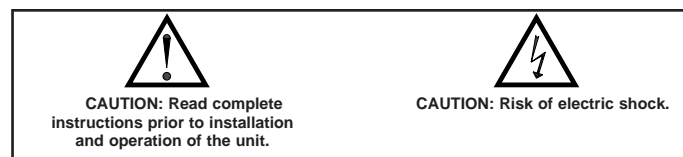

### DIMENSIONS "In inches (mm)"

Note: Recommended minimum clearance (behind the panel) for mounting clip installation is 2.1" (53.4) H x 5.0" (127) W.

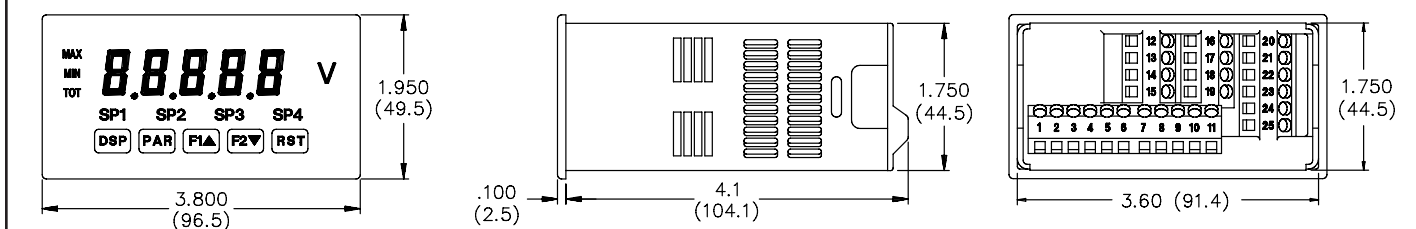

## SAFETY SUMMARY

All safety related regulations, local codes and instructions that appear in this literature or on equipment must be observed to ensure personal safety and to prevent damage to either the instrument or equipment connected to it. If equipment is used in a manner not specified by the manufacturer, the protection provided by the equipment may be impaired.

Do not use this unit to directly command motors, valves, or other actuators not equipped with safeguards. To do so can be potentially harmful to persons or equipment in the event of a fault to the unit.

## SPECIFICATIONS

1. **DISPLAY:** 5 digit, 0.56" (14.2 mm) red LED, (-19999 to 99999)

2. **POWER:**

AC Versions (DM3):

AC Power: 85 to 250 VAC, 50/60 Hz, 15 VA

Isolation: 2300 Vrms for 1 min. to all inputs and outputs.

DC Versions (DM4):

DC Power: 11 to 36 VDC, 11 W

(derate operating temperature to 40° C if operating <15 VDC and three plug-in cards are installed)

AC Power: 24 VAC, ± 10%, 50/60 Hz, 15 VA

Isolation: 500 Vrms for 1 min. to all inputs and outputs (50 V working).

3. **ANNUNCIATORS:**

MAX - maximum readout selected

MIN - minimum readout selected

TOT - totalizer readout selected, flashes when total overflows

SP1 - setpoint alarm 1 is active

SP2 - setpoint alarm 2 is active

SP3 - setpoint alarm 3 is active

SP4 - setpoint alarm 4 is active

Units Label - optional units label backlight

4. **KEYPAD:** 3 programmable function keys, 5 keys total

5. **A/D CONVERTER:** 16 bit resolution \*\*\*

6. **UPDATE RATES:**

A/D conversion rate: 20 readings/sec.

Step response: 200 msec. max. to within 99% of final readout value

(digital filter and internal zero correction disabled)\*\*

700 msec. max. (digital filter disabled, internal zero correction enabled)\*\*

Display update rate: 1 to 20 updates/sec.

Setpoint output on/off delay time: 0 to 3275 sec.

Analog output update rate: 0 to 10 sec

Max./Min. capture delay time: 0 to 3275 sec.

7. **DISPLAY MESSAGES:**

“LOL” - Appears when measurement exceeds + signal range.

“ULUL” - Appears when measurement exceeds - signal range

“...” - Appears when display values exceed + display range.

“-...” - Appears when display values exceed - display range.

8. **INPUT RANGES:**

Input Range	Accuracy* (18 to 28°C)	Accuracy* (0 to 50°C)	Impedance/ Compliance	Max Continuous Overload	Resolution ***
±200 µADC	0.03% of reading +0.03 µA	0.12% of reading +0.04 µA	1.11 Kohm	15 mA	10 nA
±2 mADC	0.03% of reading +0.3 µA	0.12% of reading +0.4 µA	111 ohm	50 mA	0.1 µA
±20 mADC	0.03% of reading +3 µA	0.12% of reading +4 µA	11.1 ohm	150 mA	1 µA
±200 mADC	0.05% of reading +30 µA	0.15% of reading +40 µA	1.1 ohm	500 mA	10 µA
±2 ADC	0.5% of reading +0.3 mA	0.7% of reading +0.4 mA	0.1 ohm	3 A	0.1 mA
±200 mVDC	0.03% of reading +30 µV	0.12% of reading +40 µV	1.066 Mohm	100V	10 µV
±2 VDC	0.03% of reading +0.3 mV	0.12% of reading +0.4 mV	1.066 Mohm	300 V	0.1 mV
±20 VDC	0.03% of reading +3 mV	0.12% of reading +4 mV	1.066 Mohm	300 V	1mV
±300 VDC	0.05% of reading +30 mV	0.15% of reading +40 mV	1.066 Mohm	300 V	10 mV
100 ohm	0.05% of reading +30 Mohm	0.2% of reading +40 Mohm	0.175 V	30 V	0.01 ohm
1000 ohm	0.05% of reading +0.3 ohm	0.2% of reading +0.4 ohm	1.75 V	30 V	0.1 ohm
10 Kohm	0.05% of reading +1 ohm	0.2% of reading +1.5 ohm	17.5 V	30 V	1 ohm

\* After 20 minute warm-up. Accuracy is specified in two ways: Accuracy over an 18 to 28°C and 10 to 75% RH environment; and accuracy over a 0 to 50°C and 0 to 85%RH (non-condensing environment). Accuracy over the 0 to 50°C range includes the temperature coefficient effect of the meter.

\*\* The meter periodically (every 12 seconds) imposes a 500 msec delay to compensate for internal zero drift. If the delay affects applications where step response is critical, it can be disabled by setting the Display Update Rate to 20/sec. In this case, add a zero error of 0.1% FS over the 0 to 50°C range.

\*\*\* The internal resolution is the full range divided by 65,535 (16 bit). For example, ±20 mA has a full range of 40 mA. 40 mA divided by 65,535 is approximately 1 µA. The resolution of 16 bit also means that the display value can only have a scaled maximum spread of 65,535.

9. **EXCITATION POWER:**

Transmitter Power: 24 VDC, ±5%, regulated, 50 mA max.

Reference Voltage: 2 VDC, ± 2%

Compliance: 1 kohm load min. (2 mA max.)

Temperature coefficient: 40 ppm/°C max.

Reference Current: 1.75 mADC, ± 2%

Compliance: 10 kohm load max.

Temperature coefficient: 40 ppm/°C max.

10. **LOW FREQUENCY NOISE REJECTION:**

Normal Mode: > 60 dB @ 50 or 60 Hz ±1%, digital filter off

Common Mode: >100 dB, DC to 120 Hz

11. **USER INPUTS:** Three programmable user inputs

Max. Continuous Input: 30 VDC

Isolation To Sensor Input Common: Not isolated

Response Time : 50 msec. max.

Logic State: Jumper selectable for sink/source logic

INPUT STATE	SINKING INPUTS 22 KΩ pull-up to +5 V	SOURCING INPUTS 22 KΩ pull-down
Active	V <sub>IN</sub> < 0.7 VDC	V <sub>IN</sub> > 2.5 VDC
Inactive	V <sub>IN</sub> > 2.5 VDC	V <sub>IN</sub> < 0.7 VDC

12. **TOTALIZER:**

Function:

Time Base: second, minute, hour, or day

Batch: Can accumulate (gate) input display from a user input

Time Accuracy: 0.01% typical

Decimal Point: 0 to 0.0000

Scale Factor: 0.001 to 65.000

Low Signal Cut-out: -19,999 to 99,999

Total: 9 digits, display alternates between high order and low order readouts

13. **CUSTOM LINEARIZATION:**

Data Point Pairs: Selectable from 2 to 16

Display Range: -19,999 to 99,999

Decimal Point: 0 to 0.0000

14. **SERIAL COMMUNICATIONS CARD:**

Type: RS485 or RS232

Isolation To Sensor & User Input Commons: 500 Vrms for 1 min.

Working Voltage: 50 V. Not Isolated from all other commons.

Data: 7/8 bits

Baud: 300 to 19,200

Parity: no, odd or even

Bus Address: Selectable 0 to 99, Max. 32 meters per line (RS485)

Transmit Delay: Selectable for 2 to 50 msec or 50 to 100 msec (RS485)

15. **DEVICENET™ CARD**

Compatibility: Group 2 Server Only, not UCMM capable

Baud Rates: 125Kbaud, 250 Kbaud, and 500 Kbaud

Bus Interface: Phillips 82C250 or equivalent with MIS wiring protection per DeviceNet™ Volume I Section 10.2.2.

Node Isolation: Bus powered, isolated node

Host Isolation: 500 Vrms for 1 minute (50V working) between DeviceNet™ and meter input common.

16. **ANALOG OUTPUT CARD:**

Types: 0 to 20 mA, 4 to 20 mA or 0 to 10 VDC

Isolation To Sensor & User Input Commons: 500 Vrms for 1 min.

Working Voltage: 50 V. Not Isolated from all other commons.

Accuracy: 0.17% of FS (18 to 28°C); 0.4% of FS (0 to 50°C)

Resolution: 1/3500

Compliance: 10 VDC: 10 KΩ load min., 20 mA: 500 Ω load max.

Update time: 200 msec. max. to within 99% of final output value (digital filter and internal zero correction disabled)

700 msec. max. (digital filter disabled, internal zero correction enabled)

**17. SETPOINT OUTPUT CARD:** Four types of field installable plug-in cards

**Dual Relay Card:**

Type: Two FORM-C relays  
 Isolation To Sensor & User Input Commons: 2000 Vrms for 1 min.  
 Working Voltage: 240 Vrms  
 Contact Rating:  
 One Relay Energized: 5 amps @ 120/240 VAC or 28 VDC (resistive load), 1/8 HP @120 VAC, inductive load  
 Total current with both relays energized not to exceed 5 amps  
 Life Expectancy: 100 K cycles min. at full load rating. External RC snubber extends relay life for operation with inductive loads  
 Response Time: 200 msec. max. to within 99% of final readout value (digital filter and internal zero correction disabled)  
 700 msec. max. (digital filter disabled, internal zero correction enabled)

**Quad Relay Card:**

Type: Four FORM-A relays  
 Isolation To Sensor & User Input Commons: 2300 Vrms for 1 min.  
 Working Voltage: 250 Vrms  
 Contact Rating:  
 One Relay Energized: 3 amps @ 250 VAC or 30 VDC (resistive load), 1/10 HP @120 VAC, inductive load  
 Total current with all four relays energized not to exceed 4 amps  
 Life Expectancy: 100K cycles min. at full load rating. External RC snubber extends relay life for operation with inductive loads  
 Response Time: 200 msec. max. to within 99% of final readout value (digital filter and internal zero correction disabled)  
 700 msec. max. (digital filter disabled, internal zero correction enabled)

**Quad Sinking Open Collector Card:**

Type: Four isolated sinking NPN transistors.  
 Isolation To Sensor & User Input Commons: 500 Vrms for 1 min.  
 Working Voltage: 50 V. Not Isolated from all other commons.  
 Rating: 100 mA max @  $V_{SAT} = 0.7$  V max.  $V_{MAX} = 30$  V  
 Response Time: 200 msec. max. to within 99% of final readout value (digital filter and internal zero correction disabled)  
 700 msec. max. (digital filter disabled, internal zero correction enabled)

**Quad Sourcing Open Collector Card:**

Type: Four isolated sourcing PNP transistors.  
 Isolation To Sensor & User Input Commons: 500 Vrms for 1 min.  
 Working Voltage: 50 V. Not Isolated from all other commons.  
 Rating: Internal supply: 24 VDC  $\pm$  10% , 30 mA max. total  
 External supply: 30 VDC max., 100 mA max. each output  
 Response Time: 200 msec. max. to within 99% of final readout value (digital filter and internal zero correction disabled)  
 700 msec. max. (digital filter disabled, internal zero correction enabled)

**18. MEMORY:** Nonvolatile E<sup>2</sup>Prom retains all programmable parameters and display values.

**19. ENVIRONMENTAL CONDITIONS:**

Operating Temperature Range: 0 to 50°C (0 to 45°C with all three plug-in cards installed)  
 Storage Temperature Range: -40 to 60°C  
 Operating and Storage Humidity: 0 to 85% max. non-condensing  
 Altitude: Up to 2000 meters

**20. CERTIFICATIONS AND COMPLIANCES:**

**ELECTROMAGNETIC COMPATIBILITY**

**Immunity to EN 50082-2**

Electrostatic discharge	EN 61000-4-2	Level 3; 8 Kv air
Electromagnetic RF fields	EN 61000-4-3	Level 3; 10 V/m <sup>1</sup> 80 MHz - 1 GHz
Fast transients (burst)	EN 61000-4-4	Level 4; 2 Kv I/O Level 3; 2 Kv power
RF conducted interference	EN 61000-4-6	Level 3; 10 V/rms 150 KHz - 80 MHz
Simulation of cordless telephones	ENV 50204	Level 3; 10 V/m 900 MHz $\pm$ 5 MHz 200 Hz, 50% duty cycle

**Emissions to EN 50081-2**

RF interference	EN 55011	Enclosure class A Power mains class A
-----------------	----------	------------------------------------------

*Notes:*

- Self-recoverable loss of performance during EMI disturbance at 10 V/m: Measurement error less than 2% of full scale.  
 For operation without loss of performance:  
 Mount unit in a metal enclosure (Buckeye SM7013-0 or equivalent)  
 Route power and I/O cables in metal conduit connected to earth ground.

**21. CONNECTIONS:** High compression cage-clamp terminal block  
 Wire Strip Length: 0.3" (7.5 mm)  
 Wire Gauge Capacity: One 14 AWG (2.55 mm) solid, two 18 AWG (1.02 mm) or four 20 AWG (0.61 mm)

**22. CONSTRUCTION:** This unit is rated for NEMA 4X/IP65 indoor use. IP20 Touch safe. Installation Category II, Pollution Degree 2. One piece bezel/case. Flame resistant. Synthetic rubber keypad. Panel gasket and mounting clip included.

**23. WEIGHT:** 10.4 oz. (295 g)

## ORDERING INFORMATION

TYPE	MODEL NO.	DESCRIPTION	PART NUMBERS
Meter	DM	Universal DC Input Panel Meter, Upgradeable, AC Powered	DM3
		Universal DC Input Panel Meter, Upgradeable, DC Powered	DM4
Optional Plug-In Cards	DMXR	Dual Setpoint Relay Output Card	DMXR2
		Quad Setpoint Relay Output Card	DMXR3
		Quad Setpoint Sinking Open Collector Output Card	DMXR4
		Quad Setpoint Sourcing Open Collector Output Card	DMXR5
	DMXD	RS485 Serial Communications Card	DMXD4
		RS232 Serial Communications Card	DMXD1
		Netbus Communications Card	DMXD2
DMXA	Analog Output Card	DMXA1	
Accessories	DMXE	Units Label Kit Accessory	DMXE2
		PC Configuration Software for Windows 3.x and 95 (3.5" disk)	DMXE9
	DMXC	External 10 ADC Current Shunt	DMXC1
		External 100 ADC Current Shunt	DMXC2

# OPTIONAL PLUG-IN CARDS AND ACCESSORIES

The DM3 series meters can be fitted with up to three optional plug-in cards. However, only one card from each function type can be installed at a time. The function types include Setpoint Alarms (DMXR), Communications (DMXD), and Analog Output (DMXA). The cards can be installed initially or at a later date. Each optional plug-in card is shipped with complete installation and programming instructions.

## SETPOINT ALARMS PLUG-IN CARDS (DMXR)

The DM3 series has four setpoint alarm output plug-in cards. Only one of these cards can be installed at a time. (Logic state of the outputs can be reversed in the programming.) These plug-in cards include:

- Dual relay, FORM-C, Normally open & closed
- Quad relay, FORM-A, Normally open only
- Isolated quad sinking NPN open collector
- Isolated quad sourcing PNP open collector

## SERIAL RS485 PLUG-IN CARD (DMXD4)

An RS485 communication port can be installed with the serial RS485 plug-in card. The RS485 option allows the connection of up to 32 meters or other devices (such as a printer, PLC, HMI, or a host computer) on a single pair of wires not longer than 4,000 feet. The address number of each meter on the line can be programmed from 0-99. Data from the meter(s) can be interrogated or changed and alarm outputs can be reset by sending the proper command string. The function keys and user inputs can be programmed to send data to a printer or other device via serial communications.

## SERIAL RS232 PLUG-IN CARD (DMXD1)

An RS232 communication port can be installed with the serial RS232 plug-in card. The RS232 is intended to allow only 2 devices, not more than 50 feet apart, to communicate to each other (such as a printer, PLC, HMI, or host computer). Data from the meter(s) can be interrogated or changed and alarm outputs can be reset by sending the proper command string. The function keys and user inputs can be programmed to send data to a printer or device via serial communication.

## DEVICENET PLUG-IN CARD (DMXD6)

A Netbus communication port can be installed with the DeviceNet plug-in card. Netbus is a high level bus protocol based upon the CAN specifications. The protocol allows the integration of devices of different types and manufacturers within a common communication framework.

## ANALOG OUTPUT PLUG-IN CARD (DMXA1)

Either a 0(4)-20 mA or 0-10 V retransmitted linear DC output is available from the analog output plug-in card. The programmable output low and high scaling can be based on the input max, min, or total display value. Reverse acting output is possible by reversing the scaling point positions.

## UNITS LABEL KIT (DMXE2)

Each meter has a units indicator with backlighting that can be customized using the Units Label Kit. The backlight is controlled in the programming.

## PC SOFTWARE (DMXE9)

The DMXE9 is a Windows based program that allows configuration of the DM3 meter from a PC. Using DMXE9 makes it easier to program the DM3 meter and allows saving the DM3 program in a PC file for future use. On-line help is available within the software. A DM3 serial plug-in card is required to program the meter using the software.

## EXTERNAL CURRENT SHUNTS (DMXC)

To measure DC current signals greater than 2 ADC, a shunt must be used. The DMXC1 current shunt converts a maximum 10 ADC signal into 10.0 mV. The DMXC2 current shunt converts a maximum 100 ADC signal into 100.0 mV. The continuous current through the shunt is limited to 115% of the rating.

# 1.0 INSTALLING THE METER

## Installation

The DM3 meets NEMA 4X/IP65 requirements for indoor use when properly installed. The unit is intended to be mounted into an enclosed panel. Prepare the panel cutout to the dimensions shown. Remove the panel latch and cardboard sleeve from the unit and discard the cardboard sleeve. Slide the panel gasket over the rear of the unit to the back of the bezel. The unit should be installed fully assembled. Insert the unit into the panel cutout.

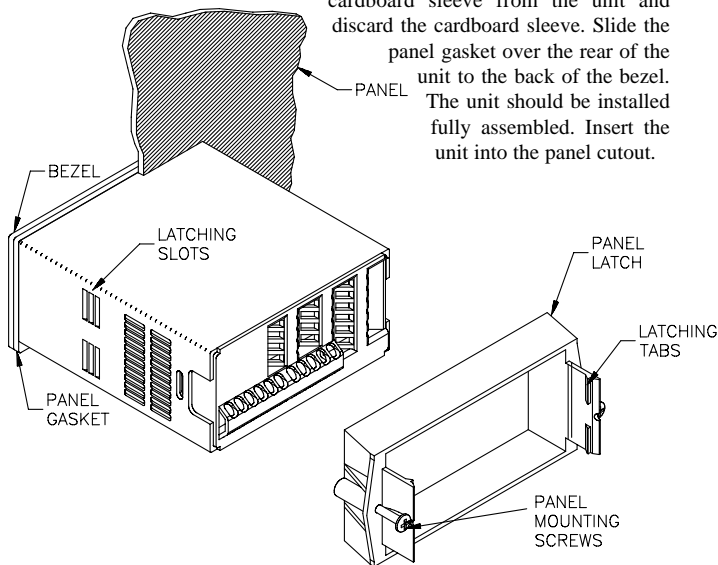

While holding the unit in place, push the panel latch over the rear of the unit so that the tabs of the panel latch engage in the slots on the case. The panel latch should be engaged in the farthest forward slot possible. To achieve a proper seal, tighten the latch screws evenly until the unit is snug in the panel (Torque to approximately 7 in-lbs [79N-cm]). Do not over-tighten the screws.

## Installation Environment

The unit should be installed in a location that does not exceed the maximum operating temperature and provides good air circulation. Placing the unit near devices that generate excessive heat should be avoided.

The bezel should be cleaned only with a soft cloth and neutral soap product. Do NOT use solvents. Continuous exposure to direct sunlight may accelerate the aging process of the bezel.

Do not use tools of any kind (screwdrivers, pens, pencils, etc.) to operate the keypad of the unit.

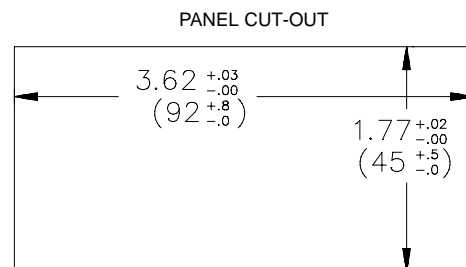

## 2.0 SETTING THE JUMPERS

The meter has three jumpers that must be checked and / or changed prior to applying power. The three jumpers are: Input Range, Excitation Output Signal, and User Input Logic. The Jumper Selections Figure is an enlargement of the jumper area shown below.

To access the jumpers, remove the meter base from the meter case by firmly squeezing and pulling back on the side rear finger tabs. This should lower the latch below the case slot (which is located just in front of the finger tabs). It is recommended to release the latch on one side, then start the other side latch.

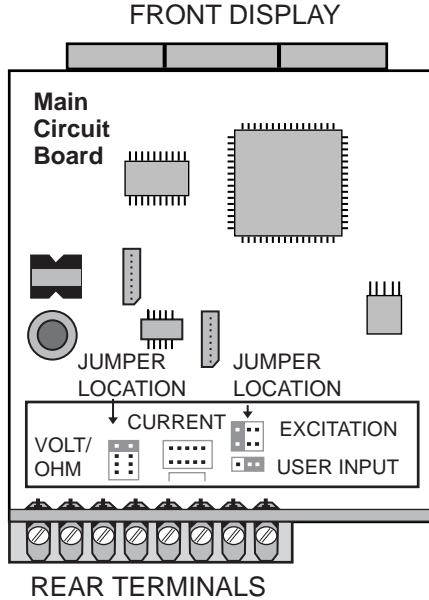

### Input Range Jumper

One jumper is used for voltage/ohms or current input ranges. Select the proper input range high enough to avoid input signal overload. Only one jumper is allowed in this area. Do not have a jumper in both the voltage and current ranges at the same time. Avoid placing the jumper across two ranges.

### Excitation Output Jumper

One jumper is used for the excitation output range. If excitation is not being used, it is not necessary to check or move this jumper.

### User Input Logic Jumper

One jumper is used for the logic state of all user inputs. If the user inputs are not used, it is not necessary to check or move this jumper.

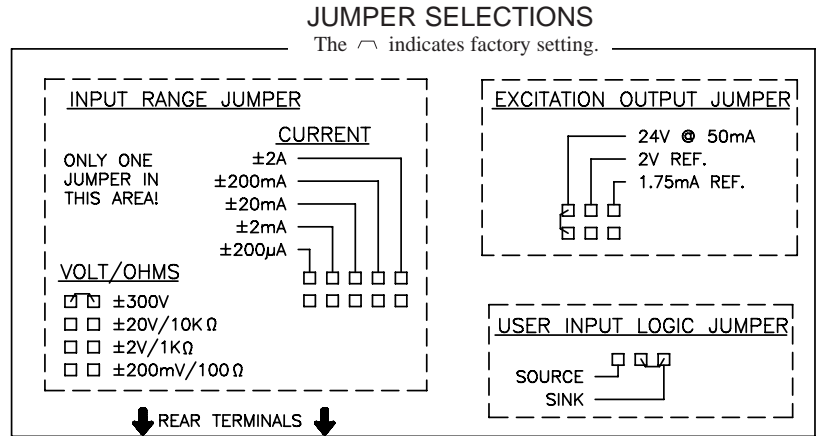

## 3.0 WIRING THE METER

### WIRING OVERVIEW

Electrical connections are made via screw-clamp terminals located on the back of the meter. All conductors should conform to the meter's voltage and current ratings. All cabling should conform to appropriate standards of good installation, local codes and regulations. It is recommended that power supplied to the meter (DC or AC) be protected by a fuse or circuit breaker.

When wiring the meter, compare the numbers embossed on the back of the meter case against those shown in wiring drawings for proper wire position. Strip the wire, leaving approximately 0.3" (7.5 mm) bare lead exposed (stranded wires should be tinned with solder). Insert the lead under the correct screw-clamp terminal and tighten until the wire is secure. (Pull wire to verify tightness.) Each terminal can accept up to one #14 AWG (2.55 mm) wire, two #18 AWG (1.02 mm), or four #20 AWG (0.61 mm).

### EMC INSTALLATION GUIDELINES

Although this meter is designed with a high degree of immunity to Electro-Magnetic Interference (EMI), proper installation and wiring methods must be followed to ensure compatibility in each application. The type of the electrical noise, source or coupling method into the unit may be different for various installations. The unit becomes more immune to EMI with fewer I/O connections. Cable length, routing and shield termination are very important and can mean the difference between a successful or a troublesome installation. Listed below are some EMC guidelines for successful installation in an industrial environment.

1. The meter should be mounted in a metal enclosure, which is properly connected to protective earth.
2. Use shielded (screened) cables for all Signal and Control inputs. The shield (screen) pigtail connection should be made as short as possible. The connection point for the shield depends somewhat upon the application. Listed below are the recommended methods of connecting the shield, in order of their effectiveness.
  - a. Connect the shield only at the panel where the unit is mounted to earth ground (protective earth).

- b. Connect the shield to earth ground at both ends of the cable, usually when the noise source frequency is above 1 MHz.
  - c. Connect the shield to common of the unit and leave the other end of the shield unconnected and insulated from earth ground.
3. Never run Signal or Control cables in the same conduit or raceway with AC power lines, conductors feeding motors, solenoids, SCR controls, and heaters, etc. The cables should be run in metal conduit that is properly grounded. This is especially useful in applications where cable runs are long and portable two-way radios are used in close proximity or if the installation is near a commercial radio transmitter.
  4. Signal or Control cables within an enclosure should be routed as far away as possible from contactors, control relays, transformers, and other noisy components.
  5. In extremely high EMI environments, the use of external EMI suppression devices, such as ferrite suppression cores, is effective. Install them on Signal and Control cables as close to the unit as possible. Loop the cable through the core several times or use multiple cores on each cable for additional protection. Install line filters on the power input cable to the unit to suppress power line interference. Install them near the power entry point of the enclosure. The following EMI suppression devices (or equivalent) are recommended:

Ferrite Suppression Cores for signal and control cables:

Fair-Rite # 0443167251 (RLC #FCOR0000)

TDK # ZCAT3035-1330A

Steward #28B2029-0A0

Line Filters for input power cables:

Schaffner # FN610-1/07 (RLC #LFIL0000)

Schaffner # FN670-1.8/07

Corcom #1VR3

*Note: Reference manufacturer's instructions when installing a line filter.*

6. Long cable runs are more susceptible to EMI pickup than short cable runs. Therefore, keep cable runs as short as possible.
7. Switching of inductive loads produces high EMI. Use of snubbers across inductive loads suppresses EMI.  
Snubber: RLC#SNUB0000.

### 3.1 POWER WIRING

#### AC Power

Terminal 1: VAC  
Terminal 2: VAC

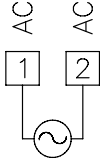

#### DC Power

Terminal 1: +VDC  
Terminal 2: -VDC

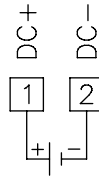

### 3.2 INPUT SIGNAL WIRING

Before connecting signal wires, the Input Range Jumper and Excitation Jumper should be verified for proper position.

#### Voltage Signal (self powered)

Terminal 3: +VDC  
Terminal 5: -VDC

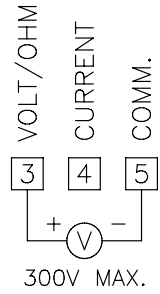

#### Current Signal (self powered)

Terminal 4: +ADC  
Terminal 5: -ADC

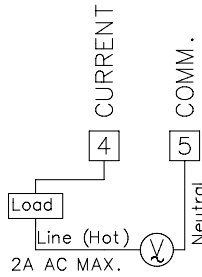

#### Current Signal (2 wire requiring excitation)

Terminal 4: -ADC  
Terminal 5: +ADC  
Excitation Jumper: 24V

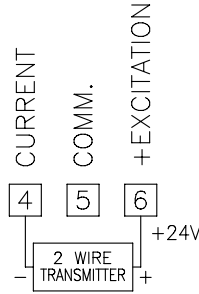

#### Current Signal (3 wire requiring excitation)

Terminal 4: +ADC (signal)  
Terminal 5: -ADC (common)  
Terminal 6: +Volt supply  
Excitation Jumper: 24V

#### Voltage Signal (3 wire requiring excitation)

Terminal 3: +VDC (signal)  
Terminal 5: -VDC (common)  
Terminal 6: +Volt supply  
Excitation Jumper: 24V

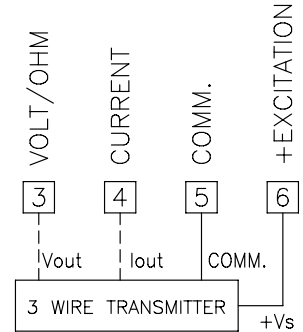

#### Resistance Signal (3 wire requiring excitation)

Terminal 3: Resistance  
Terminal 5: Resistance  
Terminal 6: Jumper to terminal 3  
Excitation Jumper: 1.75 mA REF.

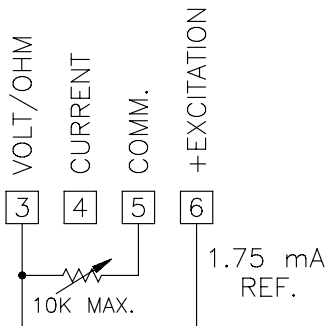

#### Potentiometer Signal (3 wire requiring excitation)

Terminal 3: Wiper  
Terminal 5: Low end of pot.  
Terminal 6: High end of pot.  
Excitation Jumper: 2V REF.  
Input Range Jumper: 2 Volt  
Module 1 Input Range: 2V

Note: The Apply signal scaling style should be used because the signal will be in volts.

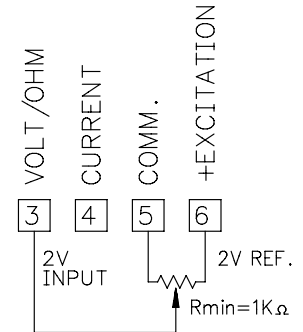

**CAUTION:** Sensor input common is NOT isolated from user input common. In order to preserve the safety of the meter application, the sensor input common must be suitably isolated from hazardous live earth referenced voltages; or input common must be at protective earth ground potential. If not, hazardous live voltage may be present at the User Inputs and User Input Common terminals. Appropriate considerations must then be given to the potential of the user input common with respect to earth common; and the common of the isolated plug-in cards with respect to input common.

### 3.3 USER INPUT WIRING

Before connecting the wires, the User Input Logic Jumper should be verified for proper position. If not using User Inputs, then skip this section. Only the appropriate User Input terminal has to be wired.

#### Sinking Logic

Terminal 8-10: } Connect external switching device between  
Terminal 7: } appropriate User Input terminal and User Comm.

In this logic, the user inputs of the meter are internally pulled up to +5 V with 22 K resistance. The input is active when it is pulled low (<0.7 V).

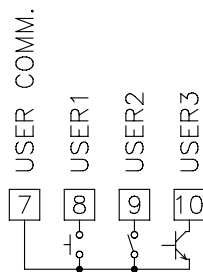

#### Sourcing Logic

Terminal 8-10: + VDC thru external switching device  
Terminal 7: -VDC thru external switching device

In this logic, the user inputs of the meter are internally pulled down to 0 V with 22 K resistance. The input is active when a voltage greater than 2.5 VDC is applied.

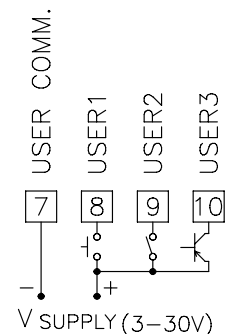

### 3.4 SETPOINT (ALARMS) WIRING

### 3.5 SERIAL COMMUNICATION WIRING

### 3.6 ANALOG OUTPUT WIRING

See appropriate plug-in card bulletin for details.

## 4.0 REVIEWING THE FRONT BUTTONS AND DISPLAY

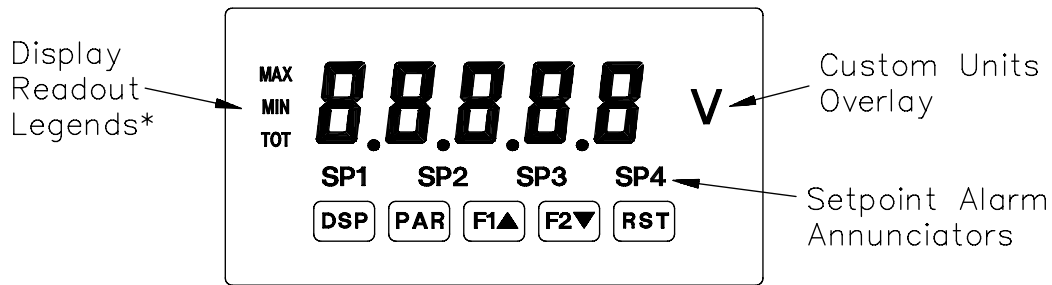

### KEY DISPLAY MODE OPERATION

<b>DSP</b>	Index display through max/min/total/input readouts
<b>PAR</b>	Access parameter list
<b>F1▲</b>	Function key 1; hold for 3 seconds for Second Function 1**
<b>F2▼</b>	Function key 2; hold for 3 seconds for Second Function 2**
<b>RST</b>	Reset (Function key)**

\* Display Readout Legends may be locked out in Factory Settings.  
 \*\* Factory setting for the F1, F2, and RST keys is NO mode.

### PROGRAMMING MODE OPERATION

	Quit programming and return to display mode
	Store selected parameter and index to next parameter
	Increment selected parameter value
	Decrement selected parameter value
	Hold with F1▲, F2▼ to scroll value by x1000

## 5.0 PROGRAMMING THE METER

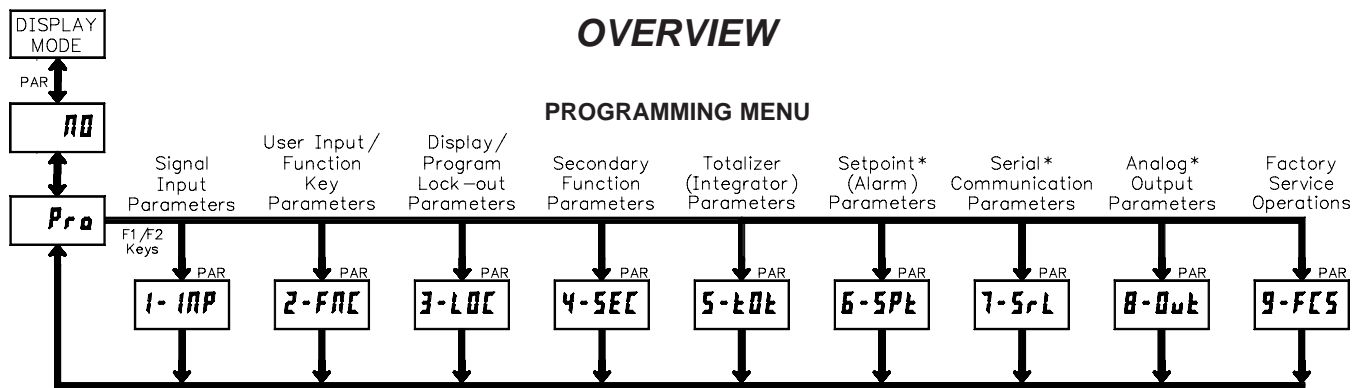

### PROGRAMMING MODE ENTRY (PAR KEY)

The Display Mode is the normal operating mode of the meter. The Programming Mode is entered by pressing the **PAR** key. If it is not accessible, then it is locked by either a security code or hardware lock.

### PARAMETER MODULE ENTRY (ARROW & PAR KEYS)

The Programming Menu is organized into modules. These modules group together parameters which are related in function. The display will alternate between **Pra** and the current parameter module. The arrow keys (**F1** and **F2**) are used to select the desired parameter module. The displayed module is entered by pressing the **PAR** key.

### PARAMETER MENU MOVEMENT (PAR KEY)

Each parameter module has a separate module menu (which is shown at the start of each parameter module discussion). The **PAR** key is pressed to advance to a particular parameter without changing the programming of preceding parameters. After completing a module, the display will return to **Pra Pr0**. Programming may continue by accessing additional parameter modules.

### SELECTION/VALUE ENTRY (ARROW & PAR KEYS)

In the parameter module, the display will alternate between the current parameter and the selections/values for that parameter. The arrow keys (**F1** and **F2**) are used to move through the selections/values for that parameter. By pressing the **PAR** key, the displayed selection is stored and activated. This will also advance the meter to the next parameter.

### PROGRAMMING MODE EXIT (DSP KEY or at Pra Pr0 PAR KEY)

The Programming Mode is exited by pressing the **DSP** key (from anywhere in the Programming Mode) or the **PAR** key (with **Pra Pr0** displayed). This will commit any stored parameter changes to memory and return the meter to the Display Mode. If a parameter was just changed, the **PAR** key should be pressed to store the change before pressing the **DSP** key. (If power loss occurs before returning to the Display Mode, verify recent parameter changes.)

### PROGRAMMING TIPS

It is recommend to start with Parameter Module 1. If lost or confused while programming, press the **DSP** key and start over. When programming is complete, it is recommended to record the parameter programming on the Parameter User Chart and lock-out parameter programming with a user input or lock-out code.

### FACTORY SETTINGS

Factory Settings may be completely restored in Parameter Module 9. This is a good starting point when experiencing programming problems. Some parameters can be left at their Factory Settings without affecting basic start-up. These parameters are identified throughout the module explanations. Try the Factory Settings unless a specific selection or value is known.

### ALTERNATING SELECTION DISPLAY

In the explanation of the parameter modules, the following dual display with arrows will appear. It is to illustrate the display alternating between the parameter on top, and the parameter's factory setting on the bottom. In most cases, selections and values for the parameter will be listed on the right.

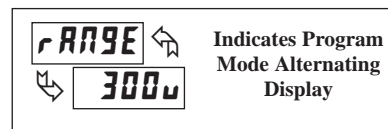

# 5.1 MODULE 1 - Signal Input Parameters (I- INP)

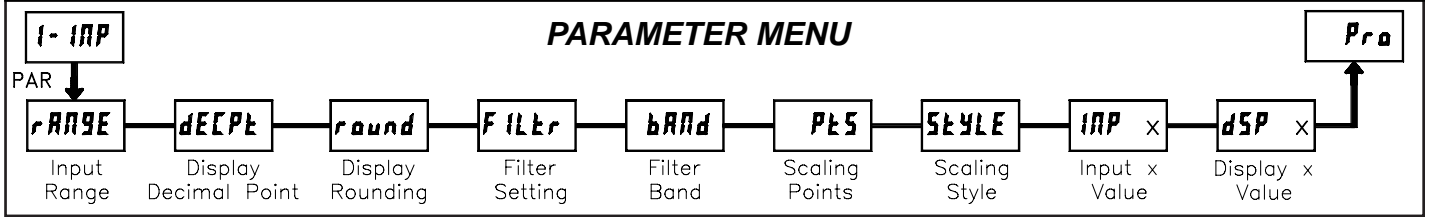

## INPUT RANGE

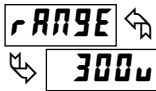

SELECTION	RANGE	RESOLUTION	SELECTION	RANGE	RESOLUTION
200uA	±200.00	µA	2u	±2.0000	V
0.002A	±2.0000	mA	20u	±20.000	V
0.02A	±20.000	mA	300u	±300.00	V
0.2A	±200.00	mA	100o	100.00	ohm
2A	±2.0000	A	1000o	1000.0	ohm
0.2u	±200.00	mV	10k	10000	ohm

Select the input range that corresponds to the external signal. This selection should be high enough to avoid input signal overload but low enough for the desired input resolution. This selection and the position of the Input Range Jumper must match.

## DISPLAY DECIMAL POINT



0    0.0    0.00    0.000    0.0000

Select the decimal point location for the Input, MAX and MIN displays. (The TOT display decimal point is a separate parameter.) This selection also affects round, dSP1 and dSP2 parameters and setpoint values.

## DISPLAY ROUNDING\*

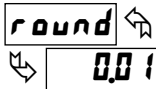

1    2    5  
10    20    50    100

Rounding selections other than one, cause the Input Display to 'round' to the nearest rounding increment selected (ie. rounding of '5' causes 122 to round to 120 and 123 to round to 125). Rounding starts at the least significant digit of the Input Display. Remaining parameter entries (scaling point values, setpoint values, etc.) are not automatically adjusted to this display rounding selection.

## FILTER SETTING\*

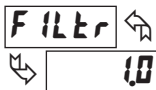

0.0 to 25.0 seconds

The input filter setting is a time constant expressed in tenths of a second. The filter settles to 99% of the final display value within approximately 3 time constants. This is an Adaptive Digital Filter which is designed to steady the Input Display reading. A value of '0' disables filtering.

## FILTER BAND\*



0.0 to 25.0 display units

The digital filter will adapt to variations in the input signal. When the variation exceeds the input filter band value, the digital filter disengages. When the variation becomes less than the band value, the filter engages again. This allows for a stable readout, but permits the display to settle rapidly after a large process change. The value of the band is in display units, independent of the Display Decimal Point position. A band setting of '0' keeps the digital filter permanently engaged.

## SCALING POINTS\*

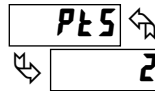

2 to 16

### Linear - Scaling Points (2)

For linear processes, only 2 scaling points are necessary. It is recommended that the 2 scaling points be at opposite ends of the input signal being applied. The points do not have to be the signal limits. Display scaling will be linear between and continue past the entered points up to the limits of the Input Signal Jumper position. Each scaling point has a coordinate-pair of Input Value (INP) and an associated desired Display Value (dSP).

### Nonlinear - Scaling Points (Greater than 2)

For non-linear processes, up to 16 scaling points may be used to provide a piece-wise linear approximation. (The greater the number of scaling points used, the greater the conformity accuracy.) The Input Display will be linear between scaling points that are sequential in program order. Each scaling point has a coordinate-pair of Input Value (INP) and an associated desired Display Value (dSP). Data from tables or equations, or empirical data could be used to derive the required number of segments and data values for the coordinate pairs. In the SFPAX software, several linearization equations are available.

## SCALING STYLE



KEY key-in data  
 APPLY apply signal

If Input Values and corresponding Display Values are known, the Key-in (KEY) scaling style can be used. This allows scaling without the presence or changing of the input signal. If Input Values have to be derived from the actual input signal source or simulator, the Apply (APPLY) scaling style must be used.

## INPUT VALUE FOR SCALING POINT 1



- 19999 to 19999

For Key-in (KEY), enter the known first Input Value by using the arrow keys. (The Input Range selection sets up the decimal location for the Input Value). For Apply (APPLY), apply the input signal to the meter, adjust the signal source externally until the desired Input Value appears. In either method, press the PAR key to enter the value being displayed. The DSP key can be pressed without changing the previously stored INP 1 value in the APPLY style.

## DISPLAY VALUE FOR SCALING POINT 1



- 19999 to 19999

Enter the first coordinating Display Value by using the arrow keys. This is the same for KEY and APPLY scaling styles. The decimal point follows the dECEPt selection.

## INPUT VALUE FOR SCALING POINT 2



- 19999 to 19999

For Key-in (KEY), enter the known second Input Value by using the arrow keys. For Apply (APPLY), adjust the signal source externally until the next desired Input Value appears. (Follow the same procedure if using more than 2 scaling points.)

\* Factory Setting can be used without affecting basic start-up.



## DISPLAY VALUE FOR SCALING POINT 2

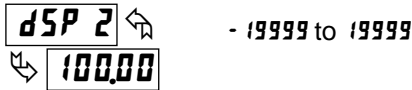

Enter the second coordinating Display Value by using the arrow keys. This is the same for **MEY** and **RPLY** scaling styles. (Follow the same procedure if using more than 2 scaling points.)

### General Notes on Scaling

1. Input Values for scaling points should be confined to the limits of the Input Range Jumper position.
2. The same Input Value should not correspond to more than one Display Value. (Example: 20 mA can not equal 0 and 10.) This is referred to as read out jumps (vertical scaled segments).
3. The same Display Value can correspond to more than one Input Value. (Example: 0 mA and 20 mA can equal 10.) This is referred to as readout dead zones (horizontal scaled segments).

4. The maximum scaled Display Value spread between range maximum and minimum is limited to 65,535. For example using +20 mA range the maximum +20 mA can be scaled to is 32,767 with 0 mA being 0 and Display Rounding of 1. (Decimal points are ignored.) The other half of 65,535 is for the lower half of the range 0 to -20 mA even if it is not used. With Display Rounding of 2, +20 mA can be scaled for  $(32,767 \times 2 =) 65,535$  but with even Input Display values shown.
5. For input levels beyond the first programmed Input Value, the meter extends the Display Value by calculating the slope from the first two coordinate pairs ( $INP1 / dSP1$  &  $INP2 / dSP2$ ). If  $INP1 = 4$  mA and  $dSP1 = 0$ , then 0 mA would be some negative Display Value. This could be prevented by making  $INP1 = 0$  mA /  $dSP1 = 0$ ,  $INP2 = 4$  mA /  $dSP2 = 0$ , with  $INP3 = 20$  mA /  $dSP3 =$  the desired high Display Value. The calculations stop at the limits of the Input Range Jumper position.
6. For input levels beyond the last programmed Input Value, the meter extends the Display Value by calculating the slope from the last two sequential coordinate pairs. If three coordinate pair scaling points were entered, then the Display Value calculation would be between  $INP2 / dSP2$  &  $INP3 / dSP3$ . The calculations stop at the limits of the Input Range Jumper position.

## 5.2 MODULE 2 - User Input and Front Panel Function Key Parameters (2-FNC)

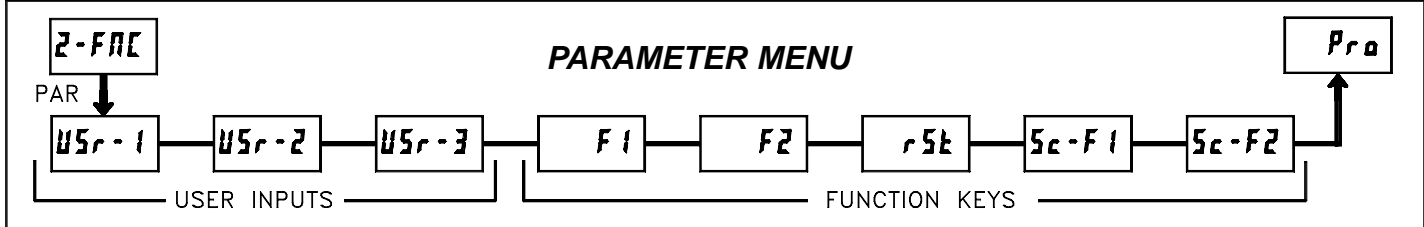

The three user inputs are individually programmable to perform specific meter control functions. While in the Display Mode or Program Mode, the function is executed the instant the user input transitions to the active state.

The front panel function keys are also individually programmable to perform specific meter control functions. While in the Display Mode, the primary function is executed the instant the key is pressed. Holding the function key for three seconds executes a secondary function. It is possible to program a secondary function without a primary function.

In most cases, if more than one user input and/or function key is programmed for the same function, the maintained (level trigger) actions will be performed while at least one of those user inputs or function keys are activated. The momentary (edge trigger) actions will be performed every time any of those user inputs or function keys transition to the active state.

**Note:** In the following explanations, not all selections are available for both user inputs and front panel function keys. Alternating displays are shown with each selection. Those selections showing both displays are available for both. If a display is not shown, it is not available for that selection. **USR-1** will represent all three user inputs. **F1** will represent all five function keys.

### NO FUNCTION



No function is performed if activated. This is the factory setting for all user inputs and function keys. No function can be selected without affecting basic start-up.

### PROGRAMMING MODE LOCK-OUT

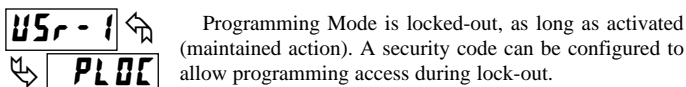

Programming Mode is locked-out, as long as activated (maintained action). A security code can be configured to allow programming access during lock-out.

### ZERO (TARE) DISPLAY



The Zero (Tare) Display provides a way to zero the Input Display value at various input levels, causing future Display readings to be offset. This function is useful in weighting applications where the container or material on the scale should not be included in the next measurement value. When activated (momentary action), **rESEt** flashes and the Display is set to zero. At the same time, the Display value (that was on the display before the Zero Display) is subtracted from the Display Offset Value and is automatically stored as the new Display Offset Value (**oFFSEt**). If another Zero (tare) Display is performed, the display will again change to zero and the Display reading will shift accordingly.

### RELATIVE/ABSOLUTE DISPLAY



This function will switch the Input Display between Relative and Absolute. The Relative is a net value that includes the Display Offset Value. The Input Display will normally show the Relative unless switched by this function. Regardless of the display selected, all meter functions continue to operate based on relative values. The Absolute is a gross value (based on Module 1 **DSP** and **INP** entries) without the Display Offset Value. The Absolute display is selected as long as the user input is activated (maintained action) or at the transition of the function key (momentary action). When the user input is released, or the function key is pressed again, the input display switches back to Relative display. **AbS** (absolute) or **rEL** (relative) is momentarily displayed at transition to indicate which display is active.

### HOLD DISPLAY

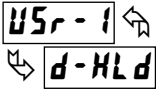

The shown display is held but all other meter functions continue as long as activated (maintained action).

### HOLD ALL FUNCTIONS

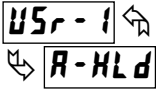

The meter disables processing the input, holds all display contents, and locks the state of all outputs as long as activated (maintained action). The serial port continues data transfer.

### SYNCHRONIZE METER READING

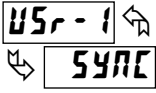

The meter suspends all functions as long as activated (maintained action). When the user input is released, the meter synchronizes the restart of the A/D with other processes or timing events.

### STORE BATCH READING IN TOTALIZER

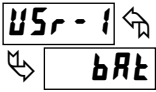

The Input Display value is one time added (batched) to the Totalizer at transition to activate (momentary action). The Totalizer retains a running sum of each batch operation until the Totalizer is reset. When this function is selected, the normal operation of the Totalizer is overridden.

### SELECT TOTALIZER DISPLAY

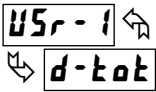

The Totalizer display is selected as long as activated (maintained action). When the user input is released, the Input Display is returned. The **DSP** key overrides the active user input. The Totalizer continues to function including associated outputs independent of being displayed.

### RESET TOTALIZER

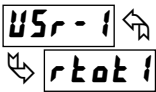

When activated (momentary action), **rESEt** flashes and the Totalizer resets to zero. The Totalizer then continues to operate as it is configured. This selection functions independent of the selected display.

### RESET AND ENABLE TOTALIZER

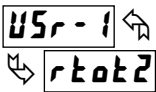

When activated (momentary action), **rESEt** flashes and the Totalizer resets to zero. The Totalizer continues to operate while active (maintained action). When the user input is released, the Totalizer stops and holds its value. This selection functions independent of the selected display.

### ENABLE TOTALIZER

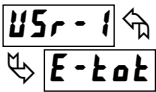

The Totalizer continues to operate as long as activated (maintained action). When the user input is released, the Totalizer stops and holds its value. This selection functions independent of the selected display.

### SELECT MAXIMUM DISPLAY

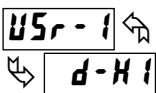

The Maximum display is selected as long as activated (maintained action). When the user input is released, the Input Display returns. The **DSP** key overrides the active user input. The Maximum continues to function independent of being displayed.

### RESET MAXIMUM

When activated (momentary action), **rESEt** flashes and the Maximum resets to the present Input Display value. The Maximum function then continues from that value. This selection functions independent of the selected display.

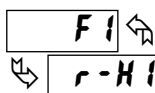

### RESET, SELECT, ENABLE MAXIMUM DISPLAY

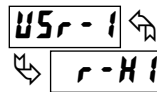

When activated (momentary action), the Maximum value is set to the present Input Display value. Maximum continues from that value while active (maintained action). When the user input is released, Maximum detection stops and holds its value. This selection functions independent of the selected display. The **DSP** key overrides the active user input display but not the Maximum function.

### SELECT MINIMUM DISPLAY

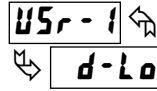

The Minimum display is selected as long as activated (maintained action). When the user input is released, the Input Display is returned. The **DSP** key overrides the active user input. The Minimum continues to function independent of being displayed.

### RESET MINIMUM

When activated (momentary action), **rESEt** flashes and the Minimum reading is set to the present Input Display value. The Minimum function then continues from that value. This selection functions independent of the selected display.

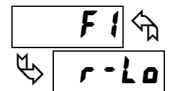

### RESET, SELECT, ENABLE MINIMUM DISPLAY

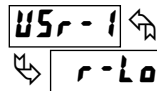

When activated (momentary action), the Minimum value is set to the present Input Display value. Minimum continues from that value while active (maintained action). When the user input is released, Minimum detection stops and holds its value. This selection functions independent of the selected display. The **DSP** key overrides the active user input display but not the Minimum function.

### RESET MAXIMUM AND MINIMUM

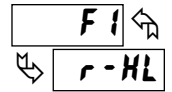
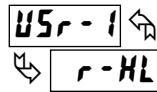

When activated (momentary action), **rESEt** flashes and the Maximum and Minimum readings are set to the present Input Display value. The Maximum and Minimum function then continues from that value. This selection functions independent of the selected display.

### SETPOINT SELECTIONS

The following selections are accessible only with the Setpoint plug-in card installed. Refer to the Setpoint Card Bulletin shipped with the Setpoint plug-in card for an explanation of their operation.

- Setpoint Card Only
- L 15t - Select main or alternate setpoints
  - r-1 - Reset Setpoint 1 (Alarm 1)
  - r-2 - Reset Setpoint 2 (Alarm 2)
  - r-3 - Reset Setpoint 3 (Alarm 3)
  - r-4 - Reset Setpoint 4 (Alarm 4)
  - r-34 - Reset Setpoint 3 & 4 (Alarm 3 & 4)
  - r-234 - Reset Setpoint 2, 3 & 4 (Alarm 2, 3 & 4)
  - r-ALL - Reset Setpoint All (Alarm All)

### PRINT REQUEST

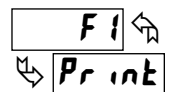
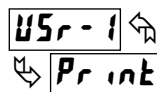

The meter issues a block print through the serial port when activated. The data transmitted during a print request is programmed in Module 7. If the user input is still active after the transmission is complete (about 100 msec), an additional transmission occurs. As long as the user input is held active, continuous transmissions occur.

## 5.3 MODULE 3 - Display and Program Lock-out Parameters (3-LOC)

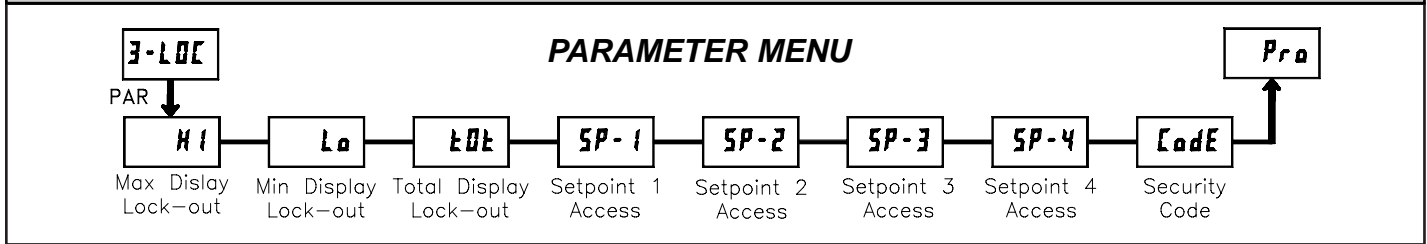

### MAXIMUM DISPLAY LOCK-OUT\* MINIMUM DISPLAY LOCK-OUT\* TOTALIZER DISPLAY LOCK-OUT\*

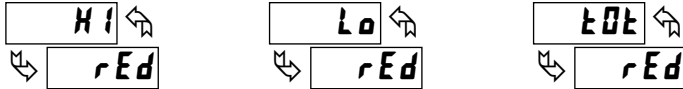

These displays can be programmed for **LOC** or **rEd**. When programmed for **LOC**, the display will not be shown when the **DSP** key is pressed regardless of Program Lock-out status. It is suggested to lock-out the display if it is not needed. The associated function will continue to operate even if its display is locked-out.

### SP-1 SP-2 SP-3 SP-4 SETPOINT ACCESS\*

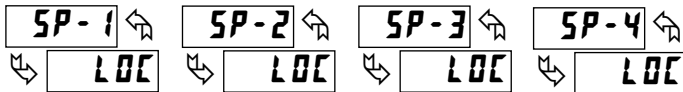

The setpoint displays can be programmed for **LOC**, **rEd** or **Ent** (See following table). Accessible only with the Setpoint plug-in card installed.

Selection	Description
<b>LOC</b>	Not visible in Display Mode.
<b>rEd</b>	Visible, but not changeable in Display Mode during Program Lock-out.
<b>Ent</b>	Visible and changeable in Display Mode during Program Lock-out.

### PROGRAM MODE SECURITY CODE\*

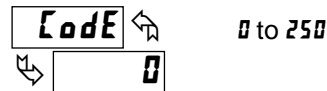

By entering any non-zero value, the prompt **Code 0** will appear when trying to access the Program Mode. Access will only be allowed after entering a matching security code or universal code of **222**. With this lock-out, a user input would not have to be configured for Program Lock-out. However, this lock-out is overridden by an inactive user input configured for Program Lock-out.

\* *Factory Setting can be used without affecting basic start-up.*

## 5.4 MODULE 4 - Secondary Function Parameters (4-SEC)

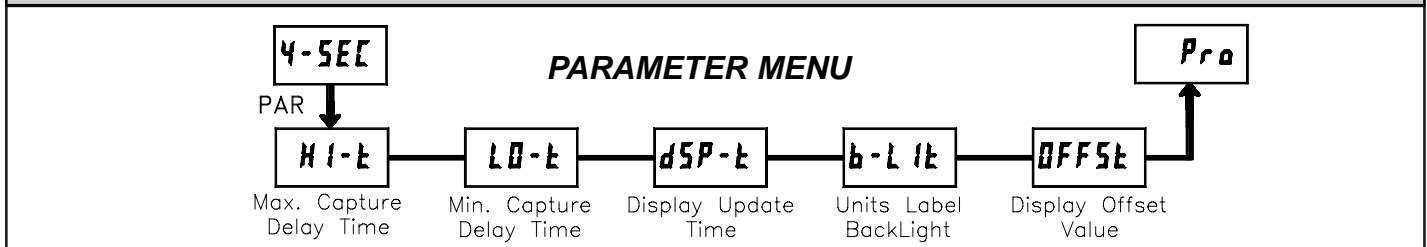

### MAX CAPTURE DELAY TIME\*



When the Input Display is above the present MAX value for the entered delay time, the meter will capture that display value as the new MAX reading. A delay time helps to avoid false captures of sudden short spikes.

### MIN CAPTURE DELAY TIME\*



When the Input Display is below the present MIN value for the entered delay time, the meter will capture that display value as the new MIN reading. A delay time helps to avoid false captures of sudden short spikes.

### DISPLAY UPDATE RATE\*

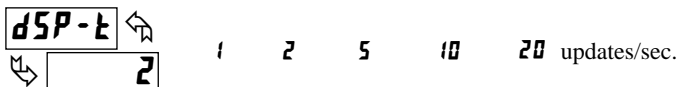

This parameter determines the rate of display update. When set to 20 updates/second, the internal re-zero compensation is disabled, allowing for the fastest possible output response.

### UNITS LABEL BACKLIGHT\*



The Units Label Kit Accessory contains a sheet of custom unit overlays which can be installed in to the meter's bezel display assembly. The backlight for these custom units is activated by this parameter.

### DISPLAY OFFSET VALUE\*

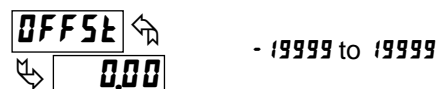

Unless a Zero Display was performed or an offset from Module 1 scaling is desired, this parameter can be skipped. The Display Offset Value is the difference from the Absolute (gross) Display value to the Relative (net) Display value for the same input level. The meter will automatically update this Display Offset Value after each Zero Display. The Display Offset Value can be directly keyed-in to intentionally add or remove display offset. See Relative / Absolute Display and Zero Display explanations in Module 2.

\* *Factory Setting can be used without affecting basic start-up.*

# 5.5 MODULE 5 - Totalizer (Integrator) Parameters (5-606)

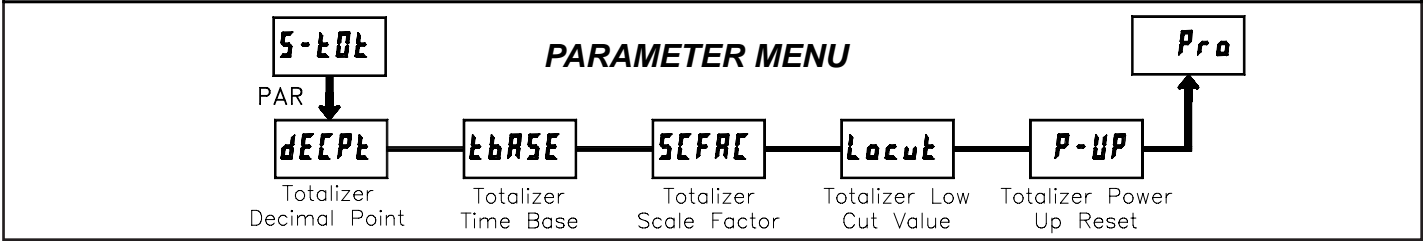

The Totalizer accumulates (integrates) the Input Display value using one of two modes. The first is using a time base. This can be used to provide an indication of total flow, usage or consumption over time. The second is through a user input or function key programmed for Batch (one time add on demand). This can be used for weighting applications where accumulation is based on a completed event. If the Totalizer is not needed, its display can be locked-out and this module can be skipped during programming.

### TOTALIZER DECIMAL POINT\*



For most applications, this matches the Input Display Decimal Point (dECPt). If a different location is desired, refer to Totalizer Scale Factor.

### TOTALIZER TIME BASE

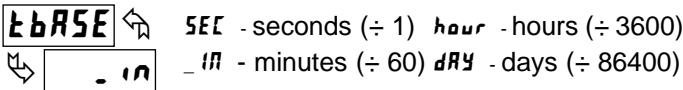

For most applications, this matches the process rate the Input Display Value represents. Example: Input Display is in gallons per minute, then use minutes time base. If the Totalizer is being accumulated through a user input programmed for Batch, then this parameter does not apply.

### TOTALIZER SCALE FACTOR\*



For most applications, the Totalizer reflects the same decimal point location and engineering units as the Input Display. In these cases, the Totalizer Scale Factor is 1.000. The Totalizer Scale Factor can be used to scale the Totalizer to a different value than the Input Display. Common possibilities are:

1. Changing decimal point location (example tenths to whole)
2. Changing engineering units (example inches to meters)
3. Changing both decimal point location and engineering units.
4. Average over a controlled time frame.

Details on calculating the scale factor are shown later.

If the Totalizer is being accumulated through a user input programmed for Batch, then this parameter does not apply.

### TOTALIZER LOW CUT VALUE\*

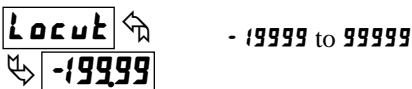

A low cut value disables Totalizer when the Input Display value falls below the value programmed.

### TOTALIZER POWER UP RESET\*

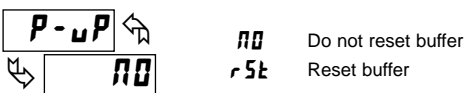

The Totalizer can be reset to zero on each meter power-up by setting this parameter to reset.

### TOTALIZER HIGH ORDER DISPLAY

When the total exceeds 5 digits, the front panel annunciator TOT flashes. In this case, the meter continues to totalize up to a 9 digit value. The high order 4 digits and the low order 5 digits of the total are displayed alternately. The letter "h" denotes the high order display.

\* Factory Setting can be used without affecting basic start-up.

### TOTALIZER BATCHING

The Totalizer Time Base and scale factor are overridden when a user input or function key is programmed for store batch (bAt). In this mode, when the user input or function key is activated, the Input Display reading is one time added to the Totalizer (batch). The Totalizer retains a running sum of each batch operation until the Totalizer is reset. This is useful in weighting operations, when the value to be added is not based on time but after a filling event.

### TOTALIZER USING TIME BASE

Totalizer accumulates as defined by:

$$\frac{\text{Input Display} \times \text{Totalizer Scale Factor}}{\text{Totalizer Time Base}}$$

Where:

- Input Display - the present input reading
- Totalizer Scale Factor - 0.001 to 65.000
- Totalizer Time Base - (the division factor of tBASE)

Example: The input reading is at a constant rate of 10.0 gallons per minute. The Totalizer is used to determine how many gallons in tenths has flowed. Because the Input Display and Totalizer are both in tenths of gallons, the Totalizer Scale Factor is 1. With gallons per minute, the Totalizer Time Base is minutes (60). By placing these values in the equation, the Totalizer will accumulate every second as follows:

$$\frac{10.0 \times 1.000}{60} = 1.667 \text{ gallon accumulates each second}$$

- This results in:
- 10.0 gallons accumulates each minute
- 600.0 gallons accumulates each hour

### TOTALIZER SCALE FACTOR CALCULATION EXAMPLES

1. When changing the Totalizer Decimal Point (dECPt) location from the Input Display Decimal Point (dECPt), the required Totalizer Scale Factor is multiplied by a power of ten.

Example: Input (dECPt)=0.0

Input (dECPt)=0.00

Totalizer dECPt	Scale Factor
0.00	10
0.0	1
0	.1
x10	.01
x100	.001

Totalizer dECPt	Scale Factor
0.000	10
0.00	1
0.0	.1
0	.01
x10	.001

(x = Totalizer display is round by tens or hundreds)

2. When changing the Totalizer engineering units, the Totalizer Scale Factor is the known conversion multiplier from Input Display units to Totalizer units. Example: If Input Display is feet and the Totalizer needs to be in yards, the conversion multiplier from feet to yards is 0.333. Enter 0.333 as the Totalizer scale factor.

3. When changing both the Totalizer engineering units and Totalizer Decimal Point then the two calculations are multiplied together. Example: Input Display = feet in tenths (0.0) with Totalizer = whole yards (0), the scale factor would be 0.033.

4. To obtain an average reading within a controlled time frame, the selected Totalizer Time Base is divided by the given time period expressed in the same timing units. Example: Average temperature per hour in 4 hour period, the scale factor would be 0.250. To achieve a controlled time frame, connect an external timer to a user input programmed for rAtkZ. The timer will control the start (reset) and the stopping (hold) of the Totalizer.

Modules 6, 7, and 8 are accessible only with the appropriate plug-in cards installed. A quick overview of each Module is listed below. Refer to the corresponding plug-in card bulletin for a more detailed explanation of each parameter selection.

## 5.6 MODULE 6 - Setpoint (Alarm) Parameters (6-SPt)

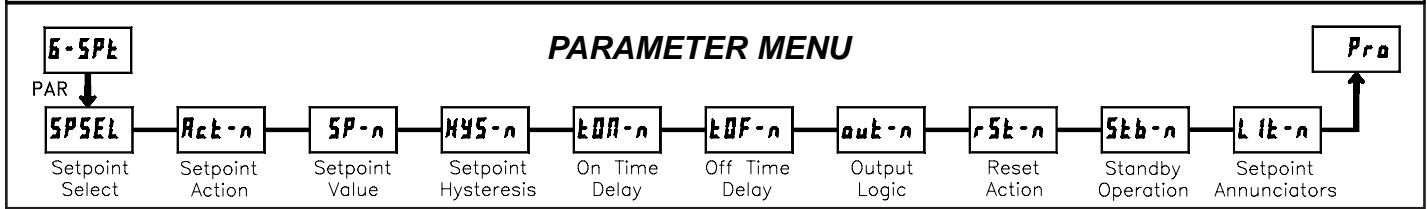

<b>SPSEL - SELECT SETPOINT</b>	00 SP-1	SP-3
	SP-2	SP-4
<b>Act-n - SETPOINT ACTION</b>	OFF	dE-HI
	Rb-HI	dE-LO
	Rb-LO	bRNd
	RU-HI	takLo
	RU-LO	takHI
<b>SP-n - SETPOINT VALUE</b>	-19999 to 99999	
<b>HYS-n - SETPOINT HYSTERESIS</b>	1 to 65000	

<b>tOn-n - ON TIME DELAY</b>	00 to 32750 sec	
<b>tOff-n - OFF TIME DELAY</b>	00 to 32750 sec	
<b>out-n - OUTPUT LOGIC</b>	nor	rEu
<b>rSt-n - RESET ACTION</b>	RUto	LALC2
	LALC1	
<b>Stb-n - STANDBY OPERATION</b>	00	YES
<b>Ltk-n - SETPOINT ANNUNCIATORS</b>	OFF	rEu
	nor	FLASH

## 5.7 MODULE 7 - Serial Communications Parameters (7-5rL)

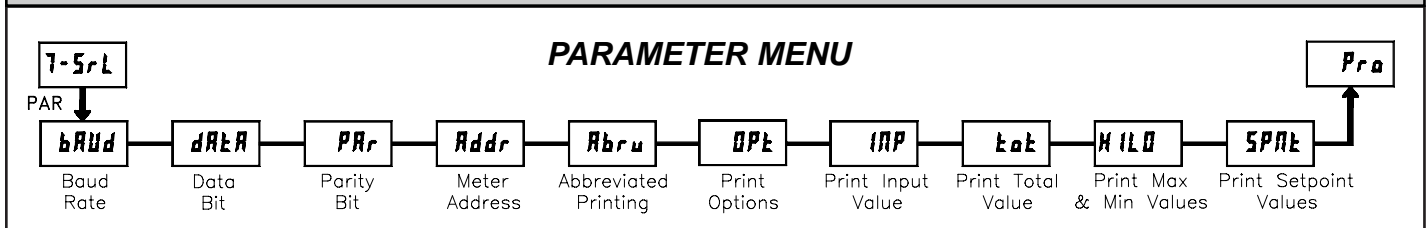

This module is for RS232 and RS485.

<b>bRud - BAUD RATE</b>	300	4800
	600	9600
	1200	19200
	2400	
<b>dRtR - DATA BITS</b>	7	8

<b>PRr - PARITY BIT</b>	Odd	00
	EVEN	
<b>Addr - METER ADDRESS</b>	0 to 99	
<b>RbrU - ABBREVIATED PRINTING</b>	00	YES
<b>OPt - PRINT OPTIONS</b>	INP	HIL0
	tot	SPnL

## 5.8 MODULE 8 - Analog Output Parameters (8-Out)

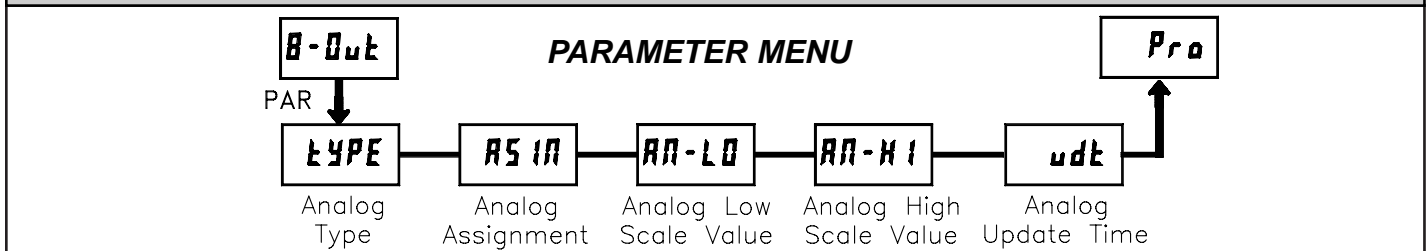

<b>tYPE - ANALOG TYPE</b>	0-20	0-10
	4-20	
<b>AS IN - ANALOG ASSIGNMENT</b>	INP	LO
	HI	tak

<b>AN-LO - ANALOG LOW SCALE VALUE</b>	-19999 to 99999	
<b>AN-HI - ANALOG HIGH SCALE VALUE</b>	-19999 to 99999	
<b>udt - ANALOG UPDATE TIME</b>	00 to 100 sec.	

## 5.9 MODULE 9 - Factory Service Operations (9-FCS)

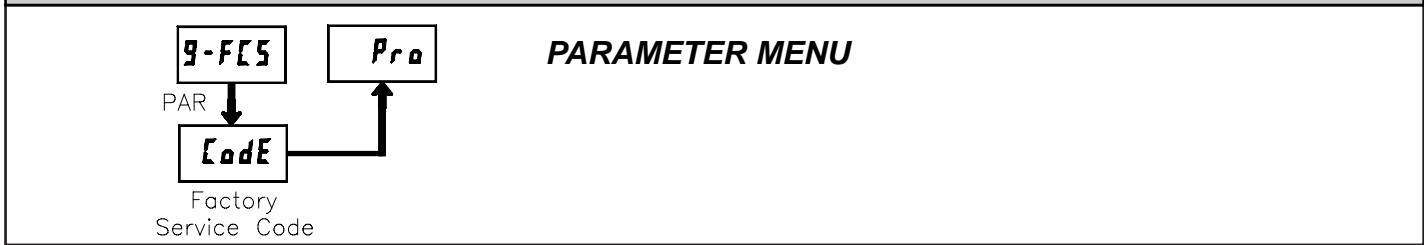

### CALIBRATION



The meter has been fully calibrated at the factory. Scaling to convert the input signal to a desired display value is performed in Module 1. If the meter appears to be indicating incorrectly or inaccurately, refer to Troubleshooting before attempting to calibrate the meter.

When recalibration is required (generally every 2 years), it should only be performed by qualified technicians using appropriate equipment. Calibration does not change any user programmed parameters. However, it may affect the accuracy of the input signal values previously stored using the Apply (**APPLY**) Scaling Style.

Calibration may be aborted by disconnecting power to the meter before exiting Module 9. In this case, the existing calibration settings remain in effect.



**WARNING:** Calibration of this meter requires a signal source with an accuracy of 0.01% or better and an external meter with an accuracy of 0.005% or better. Resistance inputs require a resistance substitution device with an accuracy of 0.01% or better.

### Input Calibration

Before starting, verify that the Input Ranger Jumper is set for the range to be calibrated. Also verify that the precision signal source is connected and ready. Allow a 30 minute warm-up period before calibrating the meter. Then perform the following procedure:

- Use the arrow keys to display **CodE 4B** and press **PAR**.
- Choose the range to be calibrated by using the arrow keys and press **PAR**. (**no** and **PAR** can be chosen to exit the calibration mode without any changes taking place.)
- When the zero range limit appears on the display, apply the appropriate:
  - Voltage ranges: dead short applied
  - Current ranges: open circuit
  - Resistance ranges: dead short with current source connected
- Press **PAR** and **----** will appear on the display for about 10 seconds.
- When the top range limit appears on the display, apply the appropriate:
  - Voltage ranges: top range value applied (The 300 V range is the exception which is calibrated with a 100 V signal.)
  - Current ranges: top range value
  - Resistance ranges: top range value (The ohms calibration requires connection of the internal current source through a resistance substitution device and the proper voltage range selection.)
- Press **PAR** and **----** will appear on the display for about 10 seconds.
- When **no** appears, press **PAR** twice.

- If the meter is not field scaled, then the input display should match the value of the input signal.
- Repeat the above procedure for each input range to be calibrated.

### Analog Output Card Calibration

Before starting, verify that the precision voltmeter (voltage output) or current meter (current output) is connected and ready. Allow a 30 minute warm-up period before calibrating the meter. Then perform the following procedure:

- Use the arrow keys to display **CodE 4B** and press **PAR**.
- Use the arrow keys to choose **OUT** and press **PAR**.
- Using the chart below, step through the five selections to be calibrated. At each prompt, use the PAXD arrow keys to adjust the external meter display to match the selection being calibrated. When the external reading matches, or if this range is not being calibrated, press **PAR**.

SELECTION	EXTERNAL METER	ACTION
00R	0.00	Adjust if necessary, press <b>PAR</b>
40R	4.00	Adjust if necessary, press <b>PAR</b>
200R	20.00	Adjust if necessary, press <b>PAR</b>
00u	0.00	Adjust if necessary, press <b>PAR</b>
100u	10.00	Adjust if necessary, press <b>PAR</b>

- When **no** appears remove the external meters and press **PAR** twice.

### RESTORE FACTORY DEFAULTS

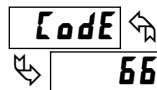

Use the arrow keys to display **CodE 6B** and press **PAR**. The meter will display **rESEt** and then return to **CodE 5B**. Press **DSP** key to return to Display Mode. This will overwrite all user settings with the factory settings.

## TROUBLESHOOTING

PROBLEM	REMEDIES
NO DISPLAY	CHECK: Power level, power connections
PROGRAM LOCKED-OUT	CHECK: Active (lock-out) user input ENTER: Security code requested
MAX, MIN, TOT LOCKED-OUT	CHECK: Module 3 programming
INCORRECT INPUT DISPLAY VALUE	CHECK: Module 1 programming, Input Range Jumper position, input connections, input signal level, Module 4 Display Offset is zero. DSP is on Input Display PERFORM: Calibration (If the above does not correct the problem.)
"OLOL" in DISPLAY (SIGNAL LOW)	CHECK: Module 1 programming, Input Range Jumper position, input connections, input signal level
"ULUL" in DISPLAY (SIGNAL HIGH)	CHECK: Module 1 programming, Input Range Jumper position, input connections, input signal level
JITTERY DISPLAY	INCREASE: Module 1 filtering, rounding, input range CHECK: Wiring is per EMC installation guidelines
MODULES or PARAMETERS NOT ACCESSIBLE	CHECK: Corresponding plug-in card installation
ERROR CODE (Err 1-4)	PRESS: RST Key (If unable to clear, contact the factory.)

For further assistance, contact technical support.

# PARAMETER VALUE CHART

## PAXD DC Input meter

Programmer \_\_\_\_\_ Date \_\_\_\_\_

Meter# \_\_\_\_\_ Security Code \_\_\_\_\_

### 1- INP Signal Input Parameters

DISPLAY	PARAMETER	FACTORY SETTING	USER SETTING
rRNGE	INPUT RANGE	300u	_____
dECPt	DISPLAY RESOLUTION	000	_____
rOund	DISPLAY ROUNDING INCREMENT	001	_____
FiltR	FILTER SETTING	10	_____
bAND	FILTER ENABLE BAND	0.10	_____
PtS	SCALING POINTS	2	_____
StYLE	SCALING STYLE	YES	_____
INP 1	INPUT VALUE 1	000	_____
dSP 1	DISPLAY VALUE 1	000	_____
INP 2	INPUT VALUE 2	100.00	_____
dSP 2	DISPLAY VALUE 2	100.00	_____
INP 3	INPUT VALUE 3	000	_____
dSP 3	DISPLAY VALUE 3	000	_____
INP 4	INPUT VALUE 4	000	_____
dSP 4	DISPLAY VALUE 4	000	_____
INP 5	INPUT VALUE 5	000	_____
dSP 5	DISPLAY VALUE 5	000	_____
INP 6	INPUT VALUE 6	000	_____
dSP 6	DISPLAY VALUE 6	000	_____
INP 7	INPUT VALUE 7	000	_____
dSP 7	DISPLAY VALUE 7	000	_____
INP 8	INPUT VALUE 8	000	_____
dSP 8	DISPLAY VALUE 8	000	_____
INP 9	INPUT VALUE 9	000	_____
dSP 9	DISPLAY VALUE 9	000	_____
INP 10	INPUT VALUE 10	000	_____
dSP 10	DISPLAY VALUE 10	000	_____
INP 11	INPUT VALUE 11	000	_____
dSP 11	DISPLAY VALUE 11	000	_____
INP 12	INPUT VALUE 12	000	_____
dSP 12	DISPLAY VALUE 12	000	_____
INP 13	INPUT VALUE 13	000	_____
dSP 13	DISPLAY VALUE 13	000	_____
INP 14	INPUT VALUE 14	000	_____
dSP 14	DISPLAY VALUE 14	000	_____
INP 15	INPUT VALUE 15	000	_____
dSP 15	DISPLAY VALUE 15	000	_____
INP 16	INPUT VALUE 16	000	_____
dSP 16	DISPLAY VALUE 16	000	_____

### 2-FNC User Input and Function Key Parameters

DISPLAY	PARAMETER	FACTORY SETTING	USER SETTING
USr-1	USER INPUT 1	NO	_____
USr-2	USER INPUT 2	NO	_____
USr-3	USER INPUT 3	NO	_____
F1	FUNCTION KEY 1	NO	_____
F2	FUNCTION KEY 2	NO	_____
rSt	RESET KEY	NO	_____
Sc-F1	2nd FUNCTION KEY 1	NO	_____
Sc-F2	2nd FUNCTION KEY 2	NO	_____

### 3-SPt Setpoint (Alarm) Parameters

DISPLAY	PARAMETER	FACTORY SETTING	USER SETTING
RCt-n	SETPOINT ACTION	OFF	_____
SP-n	SETPOINT VALUE (main)	10.00	_____
	SETPOINT VALUE (alternate)*	10.00	_____
HYS-n	SETPOINT HYSTERESIS	002	_____
tON-n	ON TIME DELAY	00	_____
tOF-n	OFF TIME DELAY	00	_____
ouT-n	OUTPUT LOGIC	nor	_____
rSt-n	RESET ACTION	RUto	_____
Stb-n	STANDBY OPERATION	NO	_____
LIt-n	SETPOINT ANNUNCIATORS	nor	_____

### 3-LCK Display and Program Lockout Parameters

DISPLAY	PARAMETER	FACTORY SETTING	USER SETTING
H1	MAX DISPLAY LOCKOUT	rEd	_____
L0	MIN DISPLAY LOCKOUT	rEd	_____
t0t	TOTAL DISPLAY LOCKOUT	rEd	_____
SP-1	SETPOINT 1 ACCESS	L0C	_____
SP-2	SETPOINT 2 ACCESS	L0C	_____
SP-3	SETPOINT 3 ACCESS	L0C	_____
SP-4	SETPOINT 4 ACCESS	L0C	_____
Code	SECURITY CODE	0	_____

### 4-SEC Secondary Function Parameters

DISPLAY	PARAMETER	FACTORY SETTING	USER SETTING
H1-t	MAX CAPTURE DELAY TIME	00	_____
L0-t	MIN CAPTURE DELAY TIME	00	_____
dSP-t	DISPLAY UPDATE TIME	2	_____
b-LIt	UNITS LABEL BACKLIGHT	OFF	_____
OFFSt	DISPLAY OFFSET VALUE	000	_____

### 5-t0t Totalizer (Integrator) Parameters

DISPLAY	PARAMETER	FACTORY SETTING	USER SETTING
dECPt	TOTALIZER DECIMAL POINT	000	_____
tBASE	TOTALIZER TIME BASE	-10	_____
SCFAC	TOTALIZER SCALE FACTOR	1000	_____
Locut	TOTALIZER LOW CUT VALUE	-199.99	_____
P-UP	TOTALIZER POWER-UP RESET	NO	_____

### 7-5rL Serial Communication Parameters

DISPLAY	PARAMETER	FACTORY SETTING	USER SETTING
bAUD	BAUD RATE	9600	_____
dAR	DATA BIT	7	_____
PAR	PARITY BIT	Odd	_____
Addr	METER ADDRESS	0	_____
Abri	ABBREVIATED PRINTING	YES	_____
INP	PRINT INPUT VALUE	YES	_____
t0t	PRINT TOTAL VALUE	YES	_____
H1L0	PRINT MAX & MIN VALUES	YES	_____
SPnt	PRINT SETPOINT VALUES	NO	_____

### 8-OUT Analog Output Parameters

DISPLAY	PARAMETER	FACTORY SETTING	USER SETTING
tYPE	ANALOG TYPE	4-20	_____
ASIn	ANALOG ASSIGNMENT	INP	_____
AN-L0	ANALOG LOW SCALE VALUE	000	_____
AN-H1	ANALOG HIGH SCALE VALUE	100.00	_____
udt	ANALOG UPDATE TIME	00	_____

\* Select alternate list to program these values.

# PAXD PROGRAMMING QUICK OVERVIEW

