

## RING SEAL FLANGED BOLT-THRU

The Reotemp Ring Seal Flanged Bolt-thru boasts an In-Line Flow-Thru design ideal for waste water, slurries, or abrasives. Mounted between pipe flanges or threaded in-line, it has a tough but sensitive elastomer lining. One unique feature of this seal is the ability to mount multiple instruments on one seal.



ORB

DIAPHRAGM SEALS

### SPECIFICATIONS

<b>Materials</b>	Body: Carbon Steel, 316 SS
<b>Wetted Materials</b>	End Flange: Carbon Steel, 316 SS. Diaphragm/Sleeve: Buna-N, PTFE EPDM, Natural Rubber and more.

<b>Process Temperature Limits</b>	<b>Sleeve Material</b>	<b>Limit</b>
	Buna-N	225°F
	Viton	400°F
	PTFE	350°F
	EPDM	300°F
	Natural Rubber	212°F

<b>Maximum Working Pressure</b>	ASME B16.5 Class 150# or 300#
---------------------------------	-------------------------------

<b>Ambient Temperature Limits</b>	Determined by the pressure instrument
-----------------------------------	---------------------------------------

<b>Wetted Materials End Flanges</b>	<b>End Flanges</b>	<b>Max Size</b>
	316L	10"
	Carbon Steel	10"
	Hastelloy C-276	4"
	Titanium	4"
	Alloy 20	4"
	Kynar (VDF)	4"
	PTFE (25% Glass Filled)	4"
	PVC	4"
	CPVC	4"

*All Non-Metallic End Flanges Rated to 150 PSIG Max*

<b>Diaphragm/Sleeve</b>	Buna N	10"
	Viton A	10"
	PTFE	10" (2" min)
	EPDM	10"
	Natural Rubber	10"

## RING SEAL FLANGED BOLT-THRU

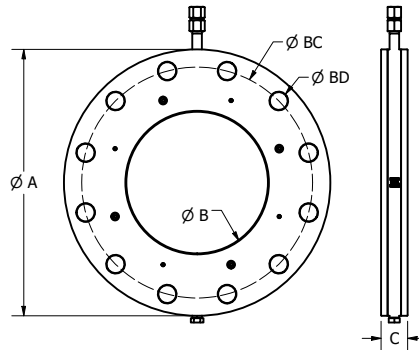

ANSI ASME Class	Nom Pipe Size (in)	Inner Dia. B (in)	Outer Dia. A (in)	Width C (in)	Bolt Circle BC (in)	Bolt Dia. BD (in)	No. of Bolt Holes	Approx. Weight (lbs)
150	1	1.05	4.25	2.00	3.12	0.625	4	5.7
	1.5	1.61	5.00	2.00	3.88	0.625	4	7.9
	2	2.07	6.00	2.00	4.75	0.75	4	12.0
	3	3.07	7.50	2.00	6.00	0.75	4	18.4
	4	4.03	9.00	1.50	7.50	0.75	8	18.6
	5	5.05	10.00	1.50	8.50	0.88	8	21.0
	6	6.07	11.00	1.50	9.50	0.88	8	23.9
	8	7.98	13.50	1.50	11.75	0.88	8	34.5
300	10	10.02	16.00	1.50	14.25	1.00	12	44.5
	2	2.07	6.50	2.00	5.00	0.75	8	13.8
	3	3.07	8.25	2.00	6.62	0.88	8	22.0
	4	4.03	10.00	1.50	7.88	0.88	8	24.5
	5	5.05	11.00	1.50	9.25	0.88	8	32.0
	6	6.07	12.50	1.50	10.62	0.88	12	34.9
	8	7.98	15.00	1.50	13.00	1.00	12	47.1
	10	10.02	17.50	1.50	15.25	1.13	16	58.8

Custom dimensions are available if your application requires. Choose -CD as option code. Alternate manufacturers dimensions may differ from above.

Liner/Sleeve Selection Chart			
Sleeve Material	Chemical Resistance	Max Temp.	Durability/Abrasion
Buna N	Most common in Wastewater market. Limited chemical compatibility.	225°F	Is an industry standard material that carries a medium/low abrasion resistance.
Viton	Good chemical resistance that can be utilized in many applications. Limited chemical compatibility.	400°F	Offers the best combination of temperature and high abrasion resistance.
EPDM	Medium level of chemical resistance. Specialized material that performs very well in specific process medias.	300°F	Offers medium abrasion resistance.
Natural Rubber	Often used in mining applications due to excellent wear properties, however, contains poor resistance to a variety of chemicals. Specialized material that performs very well in specific process medias.	212°F	Offers the highest resistance to abrasion out of the materials listed. NR is a tough material with a high durometer and stiffness.
PTFE	Offers the best chemical resistance of all listed liners.	350°F	Soft material subject to plastic deformation and cold flow. Very low resistance to abrasion.

## RING SEAL FLANGED BOLT-THRU

**HOW TO ORDER:** Choose options to build a part number. For example: **ORBCC1011X-GVA-AG-TS**

MODEL	BODY	END FLANGE	DIAPHRAGM/ SLEEVE	PIPE SIZE	FLANGE RATING	INSTRUMENT REMOVAL
<b>ORB</b>	<b>C</b>	<b>C</b>	<b>1</b>	<b>02</b>	<b>1</b>	<b>X</b>
<b>ORB</b> = Ring Seal, Flanged Bolt-thru	<b>C</b> = Carbon Steel (Green Epoxy Coated) <b>S</b> = 316 SS	<b>C</b> = Carbon Steel (Green Epoxy Coated) <b>S</b> = 316 SS <b>D</b> = Carpenter 20 <b>H</b> = Hast C-276 <b>J</b> = Titanium <b>F</b> = Solid Glass-Filled Teflon <b>K</b> = Kynar <b>Z</b> = PVC <b>W</b> = CPVC	<b>1</b> = Buna <b>2</b> = Viton <b>3</b> = PTFE <b>4</b> = EPDM <b>5</b> = Natural Rubber  Wetted	<b>01</b> = 1" Flanged; Bolt-Thru <b>0H</b> = 1.5" Flanged; Bolt-Thru <b>02</b> = 2" Flanged; Bolt-Thru <b>03</b> = 3" Flanged; Bolt-Thru <b>04</b> = 4" Flanged; Bolt-Thru <b>05</b> = 5" Flanged; Bolt-Thru <b>06</b> = 6" Flanged; Bolt-Thru <b>08</b> = 8" Flanged; Bolt-Thru <b>10</b> = 10" Flanged; Bolt-Thru	<b>1</b> = 150# ANSI Rated <b>3</b> = 300# ANSI Rated (Not available with 1" or 1.5" Size.)	<b>X</b> = Direct Mount <b>D</b> = Instrument Quick Disconnect (IQD) <b>N</b> = Needle Valve <b>B</b> = Instrument Quick Disconnect (IQD) and needle valve

DIAPHRAGM SEALS

**-GVA**

**-AG**

**-TS**

### MOUNTING

### FILL FLUID

### OPTIONS

- DTD** = Direct Mount, Threaded
- GVA** = Low Volume Goal Post Assembly; Vertical Mount; Gauge/Switch
- CVA** = Compact Tree Assembly; Vertical Mount; Gauge/Switch
- TVA** = Trident 3 Instrument Assembly; Vertical Mount; Gauge/Switch/Tranx

See Page 57 for Complete Mounting Guide

- YYY** = No Instrument Mount, Dry Seal Only

- AS** = Silicone DC200
- AG** = Glycerin USP
- BP** = Propylene Glycol

See Page 58 for Complete Fill Guide

- XX** = No Fill Fluid

- CD** = Custom Width Dimensions (for drop-in replacements)
- PP** = PulsePlus Pulsation Dampening (available with Reotemp Pressure Gauges Only)
- MR** = Certificate of Material Traceability (MTR)
- US** = American Iron & Steel (AIS) Compliant Material
- PM** = Certificate of Positive Material Identification (PMI) for metallic parts only
- HT** = Hydrostatic Testing per ASME B31.3
- TS** = SS Tag (1-10 Characters)

## SMART TRANSMITTER ATTACHMENT

### HOW TO ORDER: Unbalanced System Example

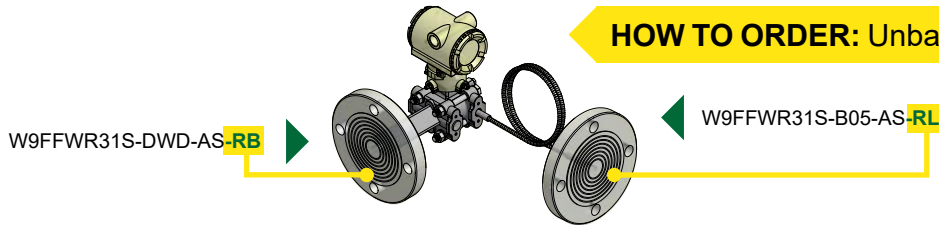

### DIFFERENTIAL PRESSURE ASSEMBLY

**Balanced System** A complete assembly with one part number that includes two diaphragm seals, two capillaries, two fills, and one complete assembly calibration certificate.

**Unbalanced DP System** Where seal, mount, capillary, or fill is not identical. A complete assembly includes one diaphragm seal on the HP side AND one diaphragm seal on the LP side.

DIAPHRAGM SEALS

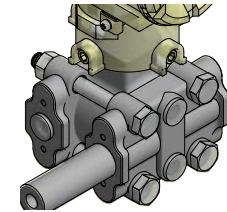
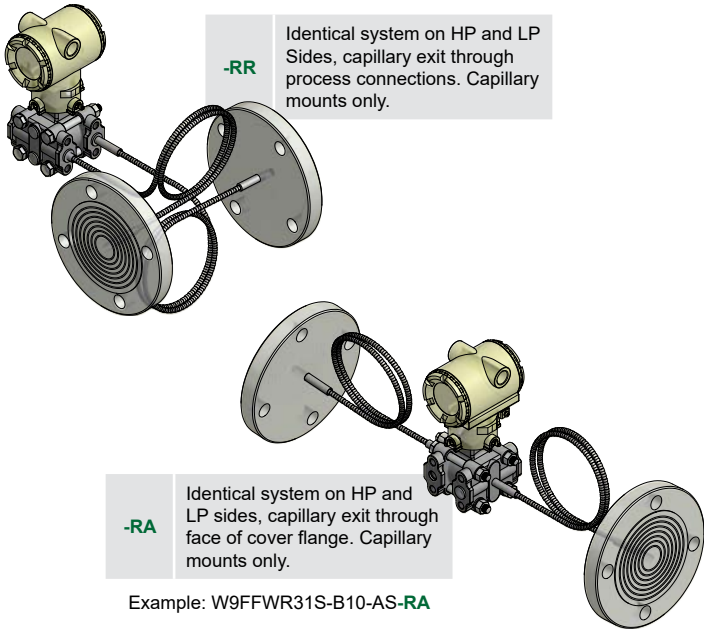

**-RH** Mount via Process Connections  
Side High Pressure

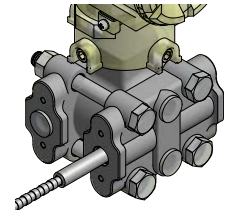

**-RL** Mount via Process Connections  
Side Low Pressure

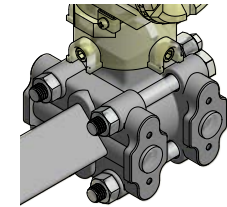

**-RB** Mount via Face of Cover Flange  
Side High Pressure

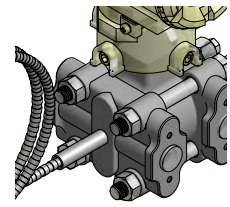

**-RC** Mount via Face of Cover Flange  
Side Low Pressure

### GAUGE PRESSURE ASSEMBLY

#### In Line Pressure Transmitter

**Traditional Mount for Gauge Pressure** Seal mount on one side only, other side is vented.



**-R1** Mount to In-Line Gauge Pressure Transmitter. Direct or remote mount.

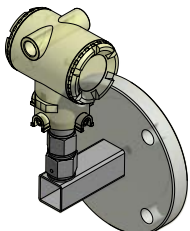

**-R4** Horizontal Mount (Tank Mount) to In-Line Gauge Pressure Transmitter. Direct mount only.

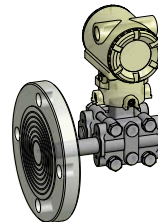

**-R2** Instrument mount through process connections, HP Side. Use "R3" if mounting to LP side

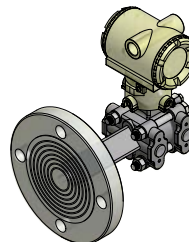

**-R8** Instrument mount through face of cover flange, HP Side. Use "R9" if mounting to LP Side

## DIAPHRAGM SEAL ASSEMBLY TO SMART TRANSMITTERS

Reotemp specializes in the unique craft of assembling diaphragm seals to field transmitters for the purpose of measuring pressure, differential pressure, level, and flow. As a trusted supplier to many of the world's leading transmitter manufacturers, Reotemp can assemble a diaphragm seal system to virtually any make or model transmitter. Every transmitter mount includes the features below to ensure superior performance and durability for every assembly. Reotemp also offers repair, refurbishment or replacement of used transmitters with remote seals.

### STANDARD FEATURES ON ALL REOTEMP ASSEMBLIES

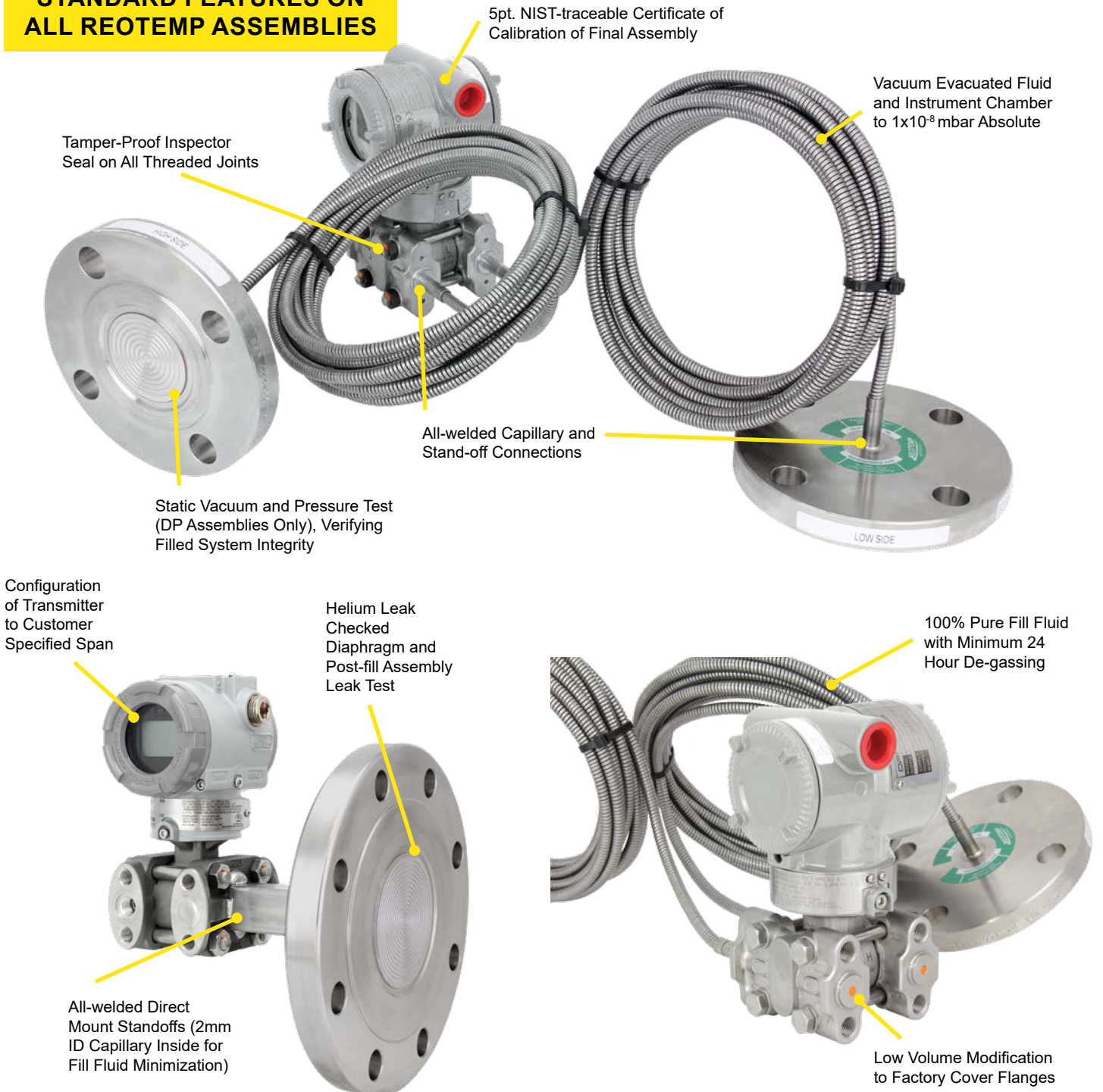

## INSTRUMENT MOUNTING CONFIGURATIONS

### DIRECT MOUNT

Direct Mounting a pressure gauge, switch, or transmitter is the most common diaphragm seal assembly.

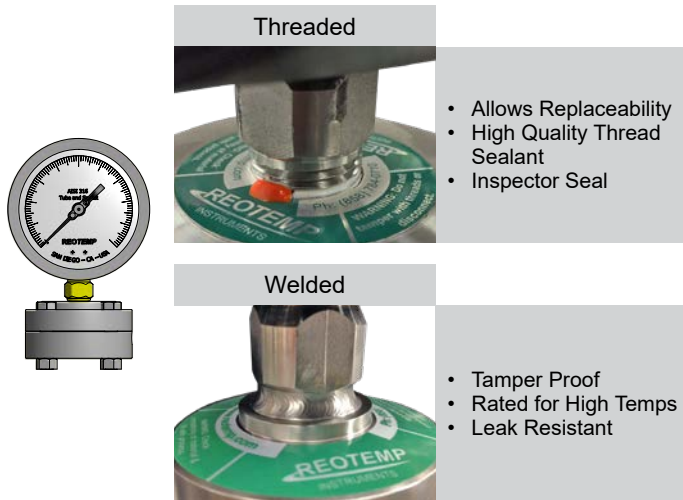

Code	Description	Max. Temp
-DTD	Threaded Instrument Connection	400°F
-DWD	Welded Instrument Connection	600°F

**Assembly Notes:** Welded connection recommended for pressure exceeding 1,500 psi for purposes of leak prevention.

### COOLING ELEMENTS

Used in either high temp or cold temp applications, Cooling Elements mounted above diaphragm seals quickly normalize fluid temperature toward ambient. This protects the pressure instrument while still maintaining the convenience of a direct mount.

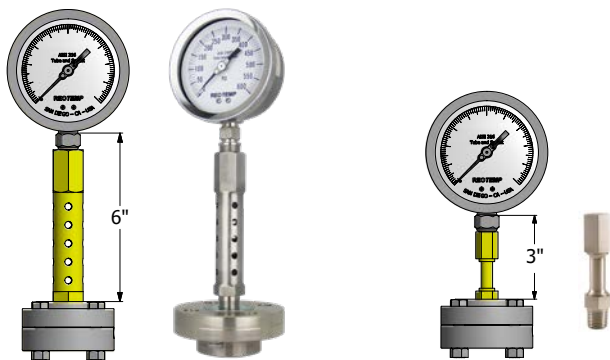

Code	Description	Max. Temp
-RTR	6" Cooling Tower	750°F
-STW	3" Cooling Standoff	600°F

**Assembly Notes:** Cooling elements are welded to diaphragm seal. Instruments are threaded to cooling element unless specified. All lengths are nominal.

### REMOTE MOUNT

Remote Mounting a pressure instrument using flexible capillary is a common mounting method when the point of measurement is in a hazardous or inconvenient location.

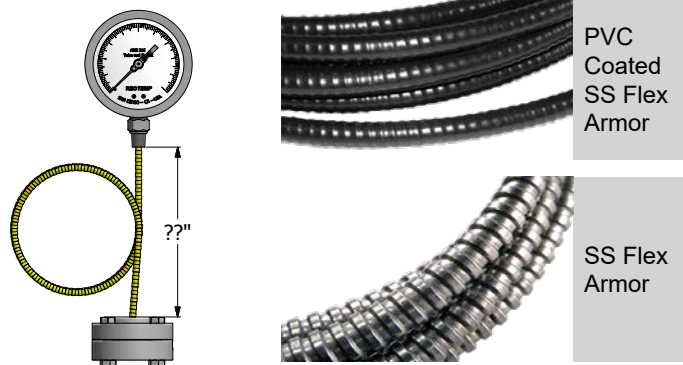

Code	Description	Max. Temp
-P??	PVC Coated SS Armor, Threaded to Seal	400°F
-W??	PVC Coated SS Armor, Welded to Seal	600°F
-A??	SS Flexible Armor, Threaded to Seal	400°F
-B??	SS Flexible Armor, Welded to Seal	750°F

Note: ?? = Length in feet (e.g. 05 = 5 feet)

**Assembly Notes:** Capillary has a 2mm inner diameter unless specified differently by customer. Ambient temp limit of PVC coated armor is 250°F. Standard instrument connection is threaded (Smart Transmitters are welded), unless specified by customer.

### TREE ASSEMBLIES

Tree Assemblies offer the ability to mount two pressure instruments onto one diaphragm seal, allowing the user to gain both a local indication and a remote signal without adding an additional pipe insertion.

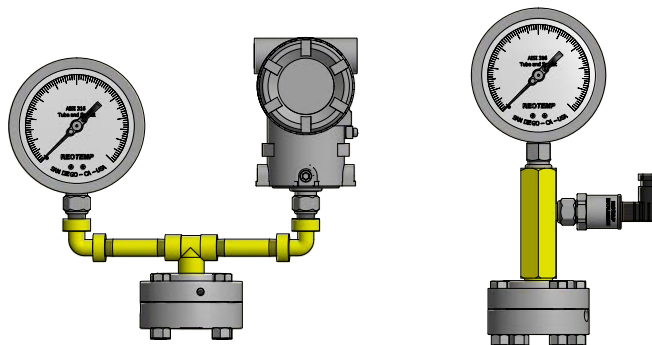

Code	Description	Max. Temp
-TRE	Goal Post, Low Pressure Assembly (Max. 150 psi)	400°F
-TRX	Goal Post, Heavy Duty (Max. 3,000 psi)	600°F
-TRM	Compact Tree Assembly (Max. 3,000 psi)	600°F

**Assembly Notes:** Threaded joints are fully welded for consistent instrument orientation. Instrument connections are threaded unless specified by customer. Diaphragm seal must displace enough fluid to drive both instruments.

## FILL GUIDE

Diaphragm seals are designed to protect pressure instruments from hot process media and corrosive chemicals while minimizing any negative effect on instrument accuracy and durability. A well-made diaphragm seal can achieve this goal only if it is properly assembled, filled, and tested. Reotemp's highly trained technicians use state-of-the-art equipment so that every diaphragm seal assembly is filled and tested to assure optimal instrument performance:

- ✓ 24-hour Minimum Fluid De-gassing
- ✓ Evacuated Instrument Chamber Up to 10<sup>-8</sup> mbar Absolute
- ✓ Complete Fill Integrity Check
- ✓ Fill-port Leak Test
- ✓ Post-fill Static Test
- ✓ Verification of Instrument Calibration
- ✓ High-temp Pipe Sealant Used on All Threaded Joints
- (Welded Joints Upon Request)
- ✓ Tamper-proof (Inspection Seal) Lacquer used on All Threaded Joints
- ✓ Sturdy Diaphragm Packaging Protection



Part Number Code	Name	Description	Temperature Range (Vacuum Service <5psia)	Pulse+™	Viscosity cst @ ~77°F	Specific Gravity @ ~77°F	Thermal Expansion cc/cc°C
<b>STANDARD FILL FLUID</b>							
AS	Silicone DC200 <sup>1</sup>	This is the standard fill fluid for most diaphragm seal applications.	-40°F to 400°F (-40°F to 250°F)	Yes	20	0.94	.00104
<b>HIGH TEMP SILICONE</b>							
BH	Silicone DC704 <sup>1</sup>	Standard for Smart Transmitters and capillary systems. Performs well in applications with high temperature and a deep vacuum.	0°F to 650°F (0°F to 450°F)	No	44	1.07	.00077
B1	Silicone DC710 <sup>1</sup>	Highest temperature rating; ideal for gauge seal assemblies. Too thick for capillary assemblies. Response time can become very slow in cold conditions.	50°F to 750°F (50°F to 400°F)	Yes	500	1.11	.00043
C8	Syltherm 800 <sup>2</sup>	Low viscosity allows it to perform well in both low and high temperatures. Not recommended for vacuum service or at high temperatures when under low static pressure.	-40°F to 750°F (-40°F to 150°F)	No	9.5	0.93	.00136
B5	Silicone DC705 <sup>1</sup>	Performs very well in high temperatures when under vacuum. The high viscosity and freezing point of this fluid makes it a poor choice for cold or outdoor installations without heat tracing.	50°F to 675°F (50°F to 550°F)	Yes	175	1.09	.00096
B2	Silicone DC550 <sup>1</sup>	Similar high temperature performance as DC705, however it performs better at lower temperatures.	-40°F to 575°F (-40°F to 400°F)	No	125	1.07	.00076
<b>FOOD GRADE</b>							
AG	Glycerin USP	This is the standard fill fluid for most gauge seal assemblies for food, beverage, and pharmaceutical applications. Its high viscosity will cause very slow response at times in low temperature and outdoor installations.	60°F to 450°F (Not Suitable)	Yes	1100	1.26	.00061
BN	NEOBEE M20 <sup>7</sup>	Low viscosity and a wide temperature range makes this the standard sanitary fill fluid for Smart Transmitters and capillary systems.	-10°F to 400°F (-10°F to 200°F)	No	10	0.92	.00101
BS	Food Grade Silicone	Highest temperature limit for food grade fluids. Because of its high viscosity it does not perform well in low temperatures.	20°F to 550°F (20°F to 250°F)	Yes	350	0.97	.00096
BP	Propylene Glycol	This is the fill fluid used when Glycol is called for on the customer specification. It has a very narrow temperature range.	0°F to 200°F (Not Suitable)	No	2.85	1.03	.00073
<b>INERT (TYPICALLY FOR CHLORINE AND OXYGEN APPLICATIONS OR IN SILICONE-FREE ENVIRONMENTS)</b>							
C1	Fomblin Y06 <sup>4</sup>	Ideal inert fluid for transmitter applications. Relatively high vapor pressure above 200°F. Not recommended for use in high temperature situations with low static pressure.	-40°F to 450°F (0°F to 250°F)	No	71	1.88	.00086
C2	Halocarbon 6.3 <sup>3</sup>	Standard inert fluid used in gauge seal assemblies.	-40°F to 400°F (-40°F to 200°F)	Yes	6.3	1.87	.00084
C3	Halocarbon 1.8 <sup>3</sup>	Typically used in low temperature applications because of its low viscosity.	-110°F to 220°F (-100°F to 100°F)	No	1.8	1.82	.00084
C4	Fluorolube FS-5 <sup>5</sup>	Similar performance to Halocarbon 6.3, however not suitable for vacuum service.	-40°F to 450°F (Not Suitable)	No	5	1.86	.00087
<b>SPECIALTY</b>							
CK	Krytox 1506 <sup>6</sup>	Specialty fill fluid, inert.	-40°F to 350°F (-40°F to 300°F)	No	62	1.88	.00095
BE	Ethylene Glycol	Occasionally used in annular (O-ring) seal assemblies.	-25°F to 320°F (Not Suitable)	No	30	1.10	.00062

1 Trademark Dow Corning

3 Trademark Halocarbon Product Corporation

5 Trademark Hooker Chemical Company

7 Trademark Stepan Specialty Products

2 Trademark The Dow Chemical Company

4 Trademark AUSIMONT S.P.A

6 Trademark The Chemours Company FC, LLC

Note: PulsePlus™ fill fluids may have different physical properties than specified. Chemical composition and temperature ranges do not vary.

## DIAPHRAGM SEAL OPTIONS



Visit [reotemp.com](http://reotemp.com)

- ✓ Check Stock
- ✓ Get Price
- ✓ Configure Part #
- ✓ Download PDF Data Sheets

DIAPHRAGM SEALS

		MS4 MS6 MS8	W5 W6 W7	T5 T6 V5	W9FF W9FR	W9XT	W9FP	DSTC75	DSTC15 AND LARGER	DSTF05	DSTF75 AND LARGER	OR	DXFR
<b>PULSATION PROTECTION (ONLY AVAILABLE WITH REOTEMP PRESSURE GAUGE MOUNTED TO SEAL)</b>													
-PP	Pulse Plus™	✓	✓	✓	✓	✓	N/A	N/A	✓	N/A	✓	✓	N/A
<b>DIAPHRAGM COATING</b>													
-AU	Gold Plated Diaphragm	N/A	✓	N/A	✓	✓	✓	✓	✓	✓	✓	N/A	N/A
-TC	Teflon Coated Diaphragm PTFE	N/A	✓	N/A	✓	✓	✓	N/A	✓	N/A	✓	N/A	N/A
-EP	Electropolished Diaphragm	N/A	N/A	N/A	N/A	N/A	N/A	✓	✓	✓	✓	N/A	N/A
<b>FILL</b>													
-FW	Fill Port Welded Closed	STD <sup>1</sup>	✓	✓	✓	✓	✓	✓	✓	✓	✓	N/A	N/A
-VF	Fill for Vacuum Service	N/A	✓	N/A	✓	✓	✓	N/A	✓	N/A	✓	N/A	N/A
<b>CLEANING AND FINISH</b>													
-DG	Degreased, Shipped in Sealed Bag	✓	✓	✓	✓	✓	✓	✓	✓	✓	✓	N/A	✓
-OX	Cleaned for Oxygen Service per ASME B40.1	✓	✓	N/A	✓	✓	✓	✓	✓	✓	✓	N/A	✓
-OY	Cleaned for Oxygen Service per MIL-STD-1330D	✓	✓	N/A	✓	✓	✓	✓	✓	✓	✓	N/A	✓
<b>PLUG FOR FLUSH PORT</b>													
-GS	1/4" SS Plug Installed	STD	STD	STD	N/A	N/A	N/A	N/A	N/A	N/A	N/A	N/A	✓
-JS	1/2" SS Plug Installed	N/A	STD	STD	N/A	N/A	N/A	N/A	N/A	N/A	N/A	N/A	✓
-GH	1/4" Hast C Plug Installed	✓	✓	✓	N/A	N/A	N/A	N/A	N/A	N/A	N/A	N/A	✓
-JH	1/2" Hast C Plug Installed	N/A	✓	✓	N/A	N/A	N/A	N/A	N/A	N/A	N/A	N/A	✓
-GM	1/4" Monel Plug Installed	N/A	✓	✓	N/A	N/A	N/A	N/A	N/A	N/A	N/A	N/A	✓
-JM	1/2" Monel Plug Installed	N/A	✓	✓	N/A	N/A	N/A	N/A	N/A	N/A	N/A	N/A	✓
<b>TAG OPTION</b>													
-TS	Stainless Steel Tag (1-10 Characters)							✓					
-TM	Stainless Steel Tag (11-80 Characters)							✓					
-TP	Paper Tag							✓					
<b>CERTIFICATION OPTIONS</b>													
-NC	Certificate of NACE Compliance	✓	✓	N/A	✓	✓	✓	N/A	N/A	✓	✓	N/A	✓
-CM	General Material Conformance	✓	✓	✓	✓	✓	✓	✓	✓	✓	✓	✓	✓
-MR	MTR - Mill Test Report Certificate	✓	✓	✓	✓	✓	✓	✓	✓	✓	✓	N/A	✓
-PM	PMI - Positive Material Identification Certificate	✓	✓	✓	✓	✓	✓	✓	✓	✓	✓	N/A	✓
-HT	Hydrostatic Test per ASME B31.3	✓	✓	✓	✓	✓	✓	✓	✓	✓	✓	N/A	N/A
-HL	Helium Leak Test Certificate	✓	✓	N/A	✓	✓	✓	✓	✓	✓	✓	N/A	N/A

✓ Indicates that the option is available  
 N/A Indicates the option is not available

<sup>1</sup> Standard on MS8, available on MS4 & MS6.