

THREADED OFFLINE NON-METALLIC DIAPHRAGM SEALS

Reotemp's Threaded Offline Non-Metallic Diaphragm Seals are designed with an upper and lower housing bolted together with a Teflon or Viton diaphragm bonded to the upper housing. This design allows for the lower housing to be removed for easy cleanout of the seal chamber while still maintaining the system fill. The Teflon and Viton diaphragms are ideal for protecting the pressure instrument from corrosive process fluid.



With Teflon Diaphragm



With Viton Diaphragm

DIAPHRAGM SEALS

SPECIFICATIONS

Diaphragm Teflon Virgin PTFE or Viton A.

Lower Housing 316/316L SS, Hast C-276, Monel A400, Alloy 20, Teflon PTFE, PVC or others.

Gasket PTFE Durlon 9600 or Viton A

Upper Housing 316/316L SS or Carbon Steel Nickel Plated

Process Temperature Limits	Lower Housing	Diaphragm	Max. Temp.
	Metallic Lower	Teflon	
Viton			300°F
Non-Metallic Lower	Teflon		140°F
	Viton		140°F

Ambient Temperature Limits Determined by the pressure instrument.

Minimum Recommended Span

	T5	T6	V5
2.5" & 3.5" Gauges	15 psi	60" H ₂ O	25" H ₂ O
4", 4.5", & 6" Gauges	15 psi	60" H ₂ O	25" H ₂ O
*Transmitter (Gauge Pressure)	15 psi	5 psi	30" H ₂ O
*Transmitter (Differential Pressure)	n/a	200" H ₂ O _d	60" H ₂ O _d
Differential Pressure Gauge (D40/42 ONLY)	n/a	300" H ₂ O _d	100" H ₂ O _d

*Warning: Non-metallic diaphragms are not recommended for critical transmitter applications.

Weight

	Metallic Lower	Non-Metallic Lower
T5	3.5 lbs	2.5 lbs
T6	5.2 lbs	4.2 lbs
V5	3.5 lbs	2.5 lbs

Note: All Weights are Approximate.

FEATURES / BENEFITS

- Removable Lower Housing Design for Easy Cleanout
- Wide Variety of Plastic and Metallic Lower Housing Materials
- Highly Sensitive and Corrosion Resistant Diaphragm
- High Displacement Diaphragms Ideal for Mechanical Differential Pressure Gauges and Low Pressure Gauges

T51/V51

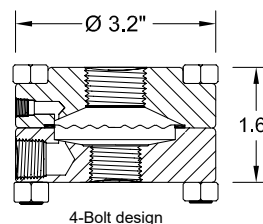

T61

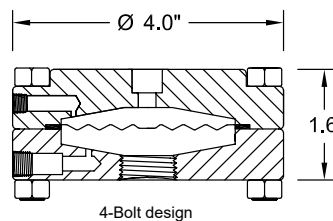

Note: All drawings depict a single 1/4" NPT Flush Port (optional). Drawing are not to scale. Contact Reotemp customer service for more detailed drawings.

Maximum Working Pressures at 100°F:

Bolts	Grade 5	Grade 8	18/8SS	316SS
Metallic Lower, T51, V51	2,500 psi	2,500 psi	1,500 psi	1,500 psi
Metallic Lower, T61	1,500 psi	1,500 psi	1,000 psi	750 psi
Non-Metallic Lower	300 psi	300 psi	300 psi	300 psi

THREADED OFFLINE NON-METALLIC DIAPHRAGM SEALS

HOW TO ORDER: Choose options to build a part number. For example: T51622TSS-TTDTD-AS-PP

T51	6	2	2	T	S	S
SEAL TYPE	FLUSH PORT	INSTRUMENT CONNECTION	PROCESS CONNECTION	DIAPHRAGM MATERIAL	LOWER HOUSING	UPPER HOUSING
T51 = 2.2" Teflon Diaphragm T61 = 2.9" Teflon Diaphragm V51 = 2.2" Viton Diaphragm	5 = No Flush Port 6 = Single 1/4" NPT 7 = Dual 1/4" NPT C = Single 1/2" NPT D = Dual 1/2" NPT	2 = 1/2" Female NPT 4 = 1/4" Female NPT	1 = 1" NPT Female 2 = 1/2" NPT Female 3 = 3/4" NPT Female 4 = 1/4" NPT Female 5 = 1.5" NPT Female (T6 ONLY) M = 1/2" NPT Male* 6 = 1.25" NPT Female 7 = 3/8" NPT Female 8 = 1/8" NPT Female 9 = 2" NPT Female (T6 ONLY)	T = Teflon Virgin PTFE V = Viton A Wetted	S = 316/316L SS H = Hast C-276 M = Monel A400 D = Alloy 20 T = Teflon PTFE ⚠️ Z = PVC ⚠️ W = CPVC ⚠️ K = Kynar ⚠️ ⚠️ Important: see note on choosing a lower housing below. Wetted	S = 316/316L SS C = Carbon Steel Nickel Plated

DIAPHRAGM SEALS

-T	T	DTD	-AS	-PP
BOLTS/FASTENERS	GASKET	INSTRUMENT MOUNT	SYSTEM FILL FLUID	OPTIONS
-5 = Carbon Steel Grade 5, Zinc Plated -8 = Carbon Steel Grade 8, Yellow Chromate -T = Stainless Steel 18/8 -S = Stainless Steel 316 See Page 89 for Complete Bolt Selection Chart	T = PTFE Durlon 9600 V = Viton A Note: Gasket material matches diaphragm material. See Page 88 for Complete Gasket Selection Guide Wetted	Direct Mount DTD = Direct Mount, Threaded DWD = Direct Mount, Welded Remote Mount A?? = Armored Capillary, 2mm, Threaded B?? = Armored Capillary, 2mm, Welded P?? = PVC Coated Armor, 2mm, Threaded W?? = PVC Coated Armor, 2mm, Welded Note: ?? = Length in feet (e.g. 05 = 5 feet) Tree Mount TRE = Goal Post, Low Pressure TRX = Goal Post, Heavy Duty TRM = Compact Tree Assembly See Page 87 for Complete Mounting Guide, Including Capillary with Different Bore Sizes	Common Fills -AS = Silicone DC200 -AG = Glycerin USP -BH = Silicone DC704 -C1 = Fomblin Y06 (inert) -C2 = Halocarbon 6.3 See Page 93 for Complete Fill Guide -XX = No Fill Fluid	-PP = Pulse Plus™ (Pulsation Protection) -FW = Fill Port Welded Closed -TS = SS Tag (1-10 Character) See Page 154 for Additional Options

YYY = Dry Seal, No Instrument



⚠️ Important Note on Choosing a Lower Housing: Reotemp recommends the use of metallic lower housings when process compatibility allows. Before specifying a non-metallic lower housing, users should be familiar with the material characteristics and risks of non-metallic materials including leaking, cracking, flowing and other issues that can affect durability and performance.

SMART TRANSMITTER ATTACHMENT

HOW TO ORDER: Unbalanced System Example

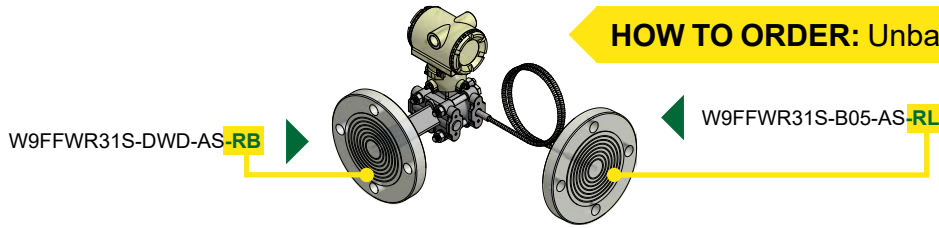

DIFFERENTIAL PRESSURE ASSEMBLY

Balanced System A complete assembly with one part number that includes two diaphragm seals, two capillaries, two fills, and one complete assembly calibration certificate.

Unbalanced DP System Where seal, mount, capillary, or fill is not identical. A complete assembly includes one diaphragm seal on the HP side AND one diaphragm seal on the LP side.

DIAPHRAGM SEALS

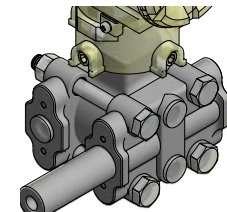
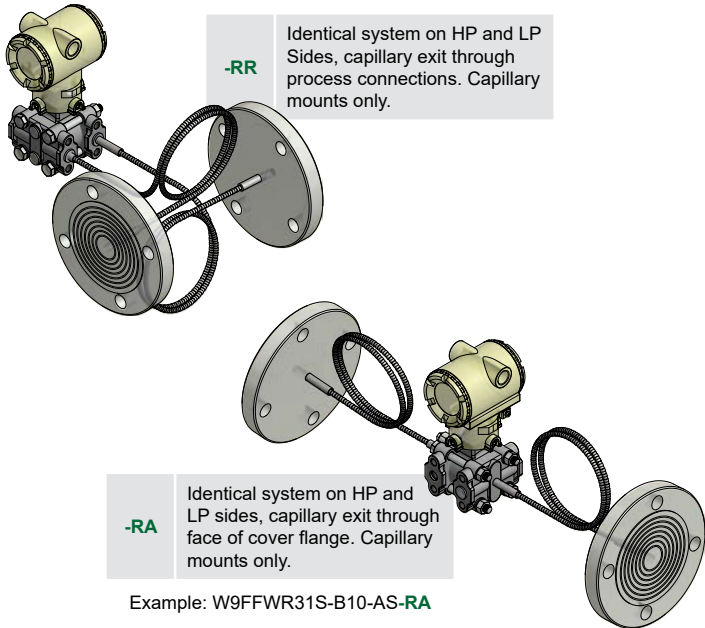

-RH Mount via Process Connections
Side High Pressure

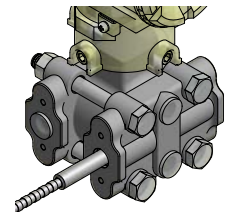

-RL Mount via Process Connections
Side Low Pressure

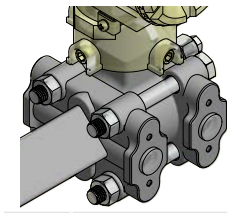

-RB Mount via Face of Cover Flange
Side High Pressure

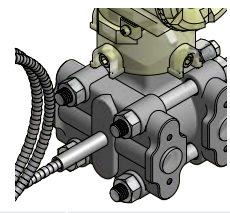

-RC Mount via Face of Cover Flange
Side Low Pressure

GAUGE PRESSURE ASSEMBLY

In Line Pressure Transmitter

Traditional Mount for Gauge Pressure Seal mount on one side only, other side is vented.



-R1 Mount to In-Line Gauge Pressure Transmitter. Direct or remote mount.

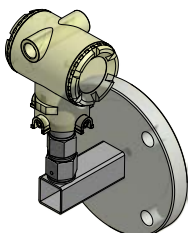

-R4 Horizontal Mount (Tank Mount) to In-Line Gauge Pressure Transmitter. Direct mount only.

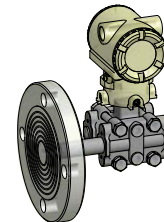

-R2 Instrument mount through process connections, HP Side. Use "R3" if mounting to LP side

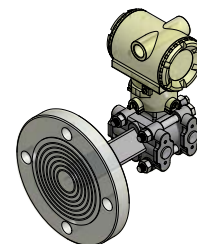

-R8 Instrument mount through face of cover flange, HP Side. Use "R9" if mounting to LP Side

DIAPHRAGM SEAL ASSEMBLY TO SMART TRANSMITTERS

Reotemp specializes in the unique craft of assembling diaphragm seals to field transmitters for the purpose of measuring pressure, differential pressure, level, and flow. As a trusted supplier to many of the world's leading transmitter manufacturers, Reotemp can assemble a diaphragm seal system to virtually any make or model transmitter. Every transmitter mount includes the features below to ensure superior performance and durability for every assembly. Reotemp also offers repair, refurbishment or replacement of used transmitters with remote seals.

STANDARD FEATURES ON ALL REOTEMP ASSEMBLIES

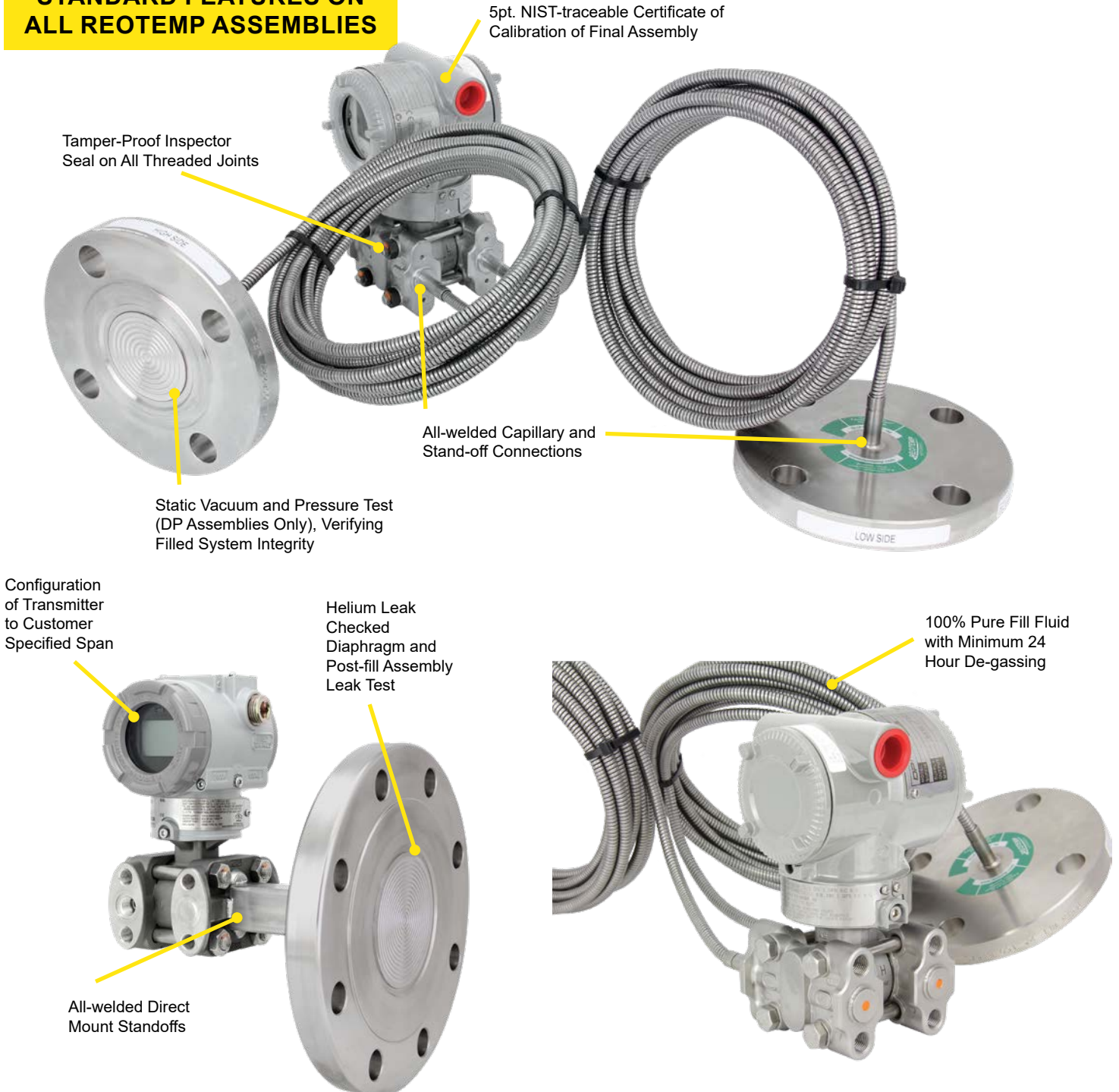

INSTRUMENT MOUNTING CONFIGURATIONS

DIRECT MOUNT

Direct Mounting a pressure gauge, switch, or transmitter is the most common diaphragm seal assembly.

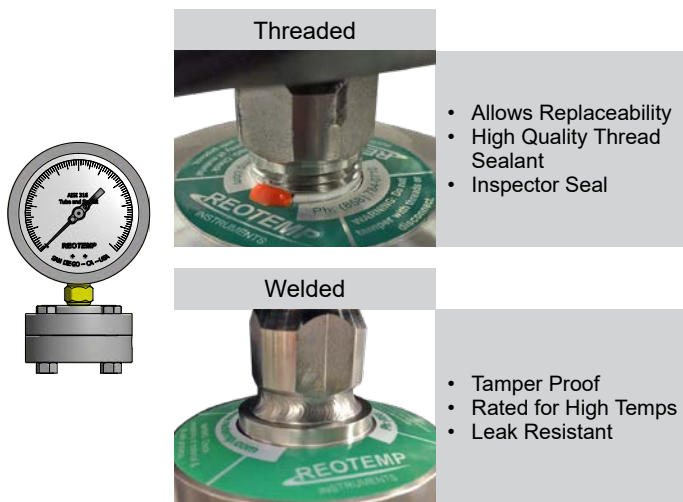

- Allows Replaceability
- High Quality Thread Sealant
- Inspector Seal

- Tamper Proof
- Rated for High Temps
- Leak Resistant

Code	Description	Max. Temp
-DTD	Threaded Instrument Connection	400°F
-DWD	Welded Instrument Connection	600°F

Assembly Notes: Welded connection recommended for pressure exceeding 1,500 psi for purposes of leak prevention.

REMOTE MOUNT

Remote Mounting a pressure instrument using flexible capillary is a common mounting method when the point of measurement is in a hazardous or inconvenient location.

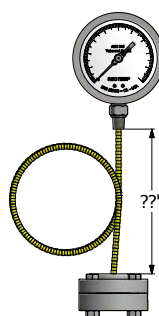

Code	Description
A	Armored, Threaded, 2mm
B	Armored, Welded, 2mm
W	PVC, Threaded, 2mm
P	PVC, Welded, 2mm
C	Armored, Threaded, 1mm
E	Armored, Welded, 1mm
F	PVC, Threaded, 1mm
G	PVC, Welded, 1mm
H	Armored, Threaded, 0.55mm
J	Armored, Welded, 0.55mm
K	PVC, Threaded, 0.55mm
L	PVC, Welded, 0.55mm

Note: ?? = Length in feet (e.g. 05 = 5 feet)

Assembly Notes: 2mm, 1mm, and .55mm are capillary inner diameter. Ambient temperature limit of PVC coated armor is 250°F. Process temperature limit of threaded connections is 400°F. Standard instrument connection is threaded (Smart Transmitters are welded), unless specified by customer.

COOLING ELEMENTS

Used in either high temp or cold temp applications, Cooling Elements mounted above diaphragm seals quickly normalize fluid temperature toward ambient. This protects the pressure instrument while still maintaining the convenience of a direct mount.

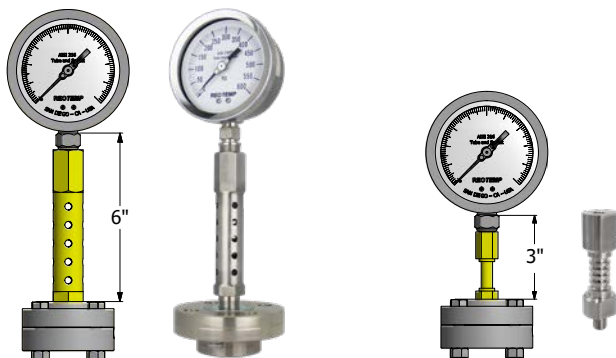

Code	Description	Max. Temp
-RTR	6" Cooling Tower	750°F
-STW	3" Cooling Standoff	600°F

Assembly Notes: Cooling elements are welded to diaphragm seal. Instruments are threaded to cooling element unless specified. All lengths are nominal.

TREE ASSEMBLIES

Tree Assemblies offer the ability to mount two pressure instruments onto one diaphragm seal, allowing the user to gain both a local indication and a remote signal without adding an additional pipe insertion.

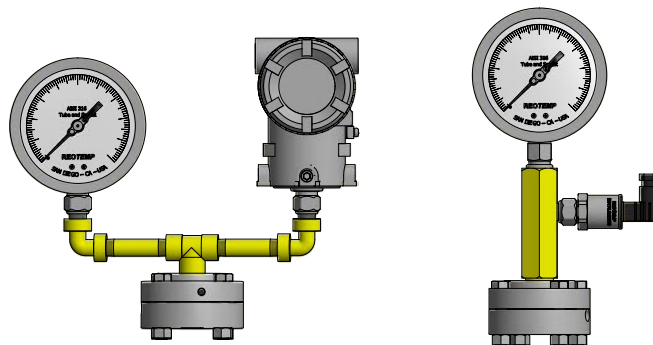

Code	Description	Max. Temp
-TRE	Goal Post, Low Pressure Assembly (Max. 150 psi)	400°F
-TRX	Goal Post, Heavy Duty (Max. 3,000 psi)	600°F
-TRM	Compact Tree Assembly (Max. 3,000 psi)	600°F

Assembly Notes: Threaded joints are fully welded for consistent instrument orientation. Instrument connections are threaded unless specified by customer. Diaphragm seal must displace enough fluid to drive both instruments.

GASKET SELECTION GUIDE

Gasket selection depends on your process temperature, reactivity and other variables. For most applications Klinger is standard however suitability for process is determined by the customer.

GASKET SELECTION CHART

Code	Material	Maximum Temperature (°F)	Minimum Temperature (°F)	Description	Common Applications	Cost
K	Klinger C4401	500°F	-110°F	Compressed aramid synthetic fiber reinforced with a nitrile binder. Excellent sealability and general purpose use	Mild inorganic and organic acids, concentrated and diluted alkalis, water, brine, industrial gases, oils, refrigerants, petroleum and derivatives	-
5	Silver Ag 3N5	750°F	-150°F	(Preferred choice for high temp, low temp, and high pressure applications) 99.95% pure silver (Ag) sheet. Exceptional sealability and use in extreme temperature and pressure applications. Only gasket that can be re-used in certain conditions	Extreme Temperatures and Pressures, Cryogenics, Nuclear, Deep Vacuum, Solvents, Alcohols, Steam, Silicone, Vegetable and Petroleum oils, Fuels	\$\$
Y	Gylon 3510	500°F	-150°F	(Preferred choice for most corrosive applications) PTFE filled with barium sulfate. Good Sealability as well as improved relaxation and cold flow resistance versus PTFE	Strong caustics, hydrocarbons, steam, chlorine, moderate acids, cryogenics, aluminum fluoride	\$\$
T	Virgin PTFE	400°F	-150°F	Polytetrafluoroethylene Resin. Exceptional chemical resistance. Poor cold flow and relaxation properties	Inert to nearly all chemicals	\$
Z	Kalrez	620°F	30°F	High temperature resistant perfluoroelastomer with excellent tensile strength, sealability, and elasticity	Oxidizing and Reactive Chemicals, Steam, Alcohols, Aldehydes, Ethers, Esters, Ketones, Acids and Bases	\$\$
C	Top Chem 2000	450°F	-150°F	PTFE filled with silicone carbide (SiC). Excellent Sealability and improved relaxation resistance over PTFE	Strong acids and alkalines, Steam, Motor fuel and oils, Aromates, Esters, Ketones, Alcohols	\$\$
M	EPDM	200°F	-20°F	Ethylene Propylene Diene Monomer Rubber. Good elasticity, Tensile Strength, and Sealability. Exhibits limited elevated temperature resistance.	Silicone and Vegetable oils, Ketones, Esters, Alkalies, Most Acids, Water	\$
V	Viton	400°F	-10°F	Fluorinated synthetic polymer or fluoroelastomer that contains excellent elasticity, tensile strength, and sealability as well as good medium temperature resistance	Variety of acids and bases, animal and vegetable oils, hydrocarbons	\$
G	Grafoil	750°F	-40°F	Made of pure compressed homogenous graphite flake with a corrosion inhibitor. Contains no binders or resins. Very fragile with very low tensile strength and elasticity	Elevated temperature processes, aggressive and corrosive chemicals, Nuclear	\$
B	Buna-N	200°F	-20°F	Also known as NBR, is a black nitrile synthetic rubber compound with excellent elasticity, tensile strength, and abrasion resistance, but exhibits poor elevated temperature characteristics	Petroleum-Based and Synthetic Oils, Alcohols, Hydraulic Fluids, Fuels, Water, Silicone Greases, Solvents	\$

DIAPHRAGM SEALS

Re-use: Re-use subject to gasket condition and presence of corrosion or pitting on mating parts. Only recommended for up to three re-use cycles. Re-assembly of the diaphragm seal to be performed per Reotemp standards and procedures to ensure proper seating.

Max Working Pressure: Gasket Selection does not impact the MWP of the configured diaphragm seal.

Process Compatibility: The listed common applications are to be used as a guide only. Actual chemical compatibility of the process with the chosen gasket material should be approved by qualified personnel.

FILL GUIDE

Diaphragm seals are designed to protect pressure instruments from hot process media and corrosive chemicals while minimizing any negative effect on instrument accuracy and durability. A well-made diaphragm seal can achieve this goal only if it is properly assembled, filled, and tested. Reotemp's highly trained technicians use state-of-the-art equipment so that every diaphragm seal assembly is filled and tested to assure optimal instrument performance:

- ✓ 24-hour Minimum Fluid De-gassing
- ✓ Evacuated Instrument Chamber Up to 10⁻⁸ mbar Absolute
- ✓ Complete Fill Integrity Check
- ✓ Fill-port Leak Test
- ✓ Post-fill Static Test
- ✓ Verification of Instrument Calibration
- ✓ High-temp Pipe Sealant Option for Joints
- ✓ Tamper-proof (Inspection Seal) Lacquer used on All Threaded Joints
- ✓ Sturdy Diaphragm Packaging Protection

Part Number Code	Name	Description	Temperature Range (Vacuum Service <5psia)		Viscosity cst @ -77°F	Specific Gravity @ -77°F	Thermal Expansion cc/cc°C
STANDARD FILL FLUID							
AS	Silicone DC200 ¹	This is the standard fill fluid for most diaphragm seal applications.	-40°F to 400°F (-40°F to 250°F)	Yes	20	0.94	.00104
HIGH TEMP SILICONE							
BH	Silicone DC704 ¹	Standard for Smart Transmitters and capillary systems. Performs well in applications with high temperature and a deep vacuum.	0°F to 650°F (0°F to 450°F)	No	44	1.07	.00077
B1	Silicone DC710 ¹	Highest temperature rating; ideal for gauge seal assemblies. Too thick for capillary assemblies. Response time can become very slow in cold conditions.	50°F to 750°F (50°F to 400°F)	Yes	500	1.11	.00043
C8	Syltherm 800 ²	Low viscosity allows it to perform well in both low and high temperatures. Not recommended for vacuum service or at high temperatures when under low static pressure.	-40°F to 750°F (-40°F to 150°F)	No	9.5	0.93	.00136
B5	Silicone DC705 ¹	Performs very well in high temperatures when under vacuum. The high viscosity and freezing point of this fluid makes it a poor choice for cold or outdoor installations without heat tracing.	50°F to 675°F (50°F to 550°F)	Yes	175	1.09	.00096
B2	Silicone DC550 ¹	Similar high temperature performance as DC705, however it performs better at lower temperatures.	-40°F to 575°F (-40°F to 400°F)	No	125	1.07	.00076
FOOD GRADE							
AG	Glycerin USP	This is the standard fill fluid for most gauge seal assemblies for food, beverage, and pharmaceutical applications. Its high viscosity will cause very slow response at times in low temperature and outdoor installations.	60°F to 450°F (Not Suitable)	Yes	1100	1.26	.00061
BN	NEOBEE M20 ⁷	Low viscosity and a wide temperature range makes this the standard sanitary fill fluid for Smart Transmitters and capillary systems.	-10°F to 400°F (-10°F to 200°F)	No	10	0.92	.00101
BS	Food Grade Silicone	Highest temperature limit for food grade fluids. Because of its high viscosity it does not perform well in low temperatures.	20°F to 550°F (20°F to 250°F)	Yes	350	0.97	.00096
BP	Propylene Glycol	This is the fill fluid used when Glycol is called for on the customer specification. It has a very narrow temperature range.	0°F to 200°F (Not Suitable)	No	2.85	1.03	.00073
INERT (TYPICALLY FOR CHLORINE AND OXYGEN APPLICATIONS OR IN SILICONE-FREE ENVIRONMENTS)							
C1	Fomblin Y06 ⁴	Ideal inert fluid for transmitter applications. Relatively high vapor pressure above 200°F. Not recommended for use in high temperature situations with low static pressure.	-40°F to 450°F (0°F to 250°F)	No	71	1.88	.00086
C2	Halocarbon 6.3 ³	Standard inert fluid used in gauge seal assemblies.	-40°F to 400°F (-40°F to 200°F)	Yes	6.3	1.87	.00084
C3	Halocarbon 1.8 ³	Typically used in low temperature applications because of its low viscosity.	-110°F to 220°F (-100°F to 100°F)	No	1.8	1.82	.00084
C4	Fluorolube FS-5 ⁵	Similar performance to Halocarbon 6.3, however not suitable for vacuum service.	-40°F to 450°F (Not Suitable)	No	5	1.86	.00087
SPECIALTY							
CK	Krytox 1506 ⁶	Specialty fill fluid, inert.	-40°F to 350°F (-40°F to 300°F)	No	62	1.88	.00095
BE	Ethylene Glycol	Occasionally used in annular (O-ring) seal assemblies.	-25°F to 320°F (Not Suitable)	No	30	1.10	.00062
CT	Syltherm XLT ²	Used for very low process temperatures.	-150°F to 500°F (Not Suitable)	No	1.4	0.85	.00168

1 Trademark Dow Corning

3 Trademark Halocarbon Product Corporation

5 Trademark Hooker Chemical Company

7 Trademark Stepan Specialty Products

2 Trademark The Dow Chemical Company

4 Trademark AUSIMONT S.P.A

6 Trademark The Chemours Company FC, LLC

Note: PulsePlus™ fill fluids may have different physical properties than specified. Chemical composition and temperature ranges do not vary.

DIAPHRAGM SEALS

DIAPHRAGM SEALS

DIAPHRAGM SEAL OPTIONS

DIAPHRAGM SEALS

		MS4 MS6 MS8	W5 W6 W7	T5 T6 V5	W9FF W9FR	W9XT	W9FP	DSTC75	DSTC15 AND LARGER	DSTF05	DSTF75 AND LARGER	OR	DXFR
PULSATION PROTECTION (ONLY AVAILABLE WITH REOTEMP PRESSURE GAUGE MOUNTED TO SEAL)													
-PP	Pulse Plus™	✓	✓	✓	✓	✓	N/A	N/A	✓	N/A	✓	✓	N/A
DIAPHRAGM COATING													
-AU	Gold Plated Diaphragm	N/A	✓	N/A	✓	✓	✓	✓	✓	✓	✓	N/A	N/A
-TC	Teflon Coated Diaphragm PTFE	N/A	✓	N/A	✓	✓	✓	N/A	✓	N/A	✓	N/A	N/A
-EP	Electropolished Diaphragm	N/A	N/A	N/A	N/A	N/A	N/A	✓	✓	✓	✓	N/A	N/A
FILL													
-FW	Fill Port Welded Closed	STD ¹	✓	✓	✓	✓	✓	✓	✓	✓	✓	N/A	N/A
-VF	Fill for Vacuum Service	N/A	✓	N/A	✓	✓	✓	N/A	✓	N/A	✓	N/A	N/A
CLEANING AND FINISH													
-DG	Degreased, Shipped in Sealed Bag	✓	✓	✓	✓	✓	✓	✓	✓	✓	✓	N/A	✓
-OX	Cleaned for Oxygen Service per ASME B40.1	✓	✓	N/A	✓	✓	✓	✓	✓	✓	✓	N/A	✓
-OY	Cleaned for Oxygen Service per MIL-STD-1330D	✓	✓	N/A	✓	✓	✓	✓	✓	✓	✓	N/A	✓
PLUG FOR FLUSH PORT													
-GS	1/4" SS Plug Installed	STD	STD	STD	N/A	N/A	N/A	N/A	N/A	N/A	N/A	N/A	✓
-JS	1/2" SS Plug Installed	N/A	STD	STD	N/A	N/A	N/A	N/A	N/A	N/A	N/A	N/A	✓
-GH	1/4" Hast C Plug Installed	✓	✓	✓	N/A	N/A	N/A	N/A	N/A	N/A	N/A	N/A	✓
-JH	1/2" Hast C Plug Installed	N/A	✓	✓	N/A	N/A	N/A	N/A	N/A	N/A	N/A	N/A	✓
-GM	1/4" Monel Plug Installed	N/A	✓	✓	N/A	N/A	N/A	N/A	N/A	N/A	N/A	N/A	✓
-JM	1/2" Monel Plug Installed	N/A	✓	✓	N/A	N/A	N/A	N/A	N/A	N/A	N/A	N/A	✓
TAG OPTION													
-TS	Stainless Steel Tag (1-10 Characters)							✓					
-TM	Stainless Steel Tag (11-80 Characters)							✓					
-TP	Paper Tag							✓					
CERTIFICATION OPTIONS													
-NC	Certificate of NACE Compliance	✓	✓	N/A	✓	✓	✓	N/A	N/A	✓	✓	N/A	✓
-CM	General Material Conformance	✓	✓	✓	✓	✓	✓	✓	✓	✓	✓	✓	✓
-MR	MTR - Mill Test Report Certificate	✓	✓	✓	✓	✓	✓	✓	✓	✓	✓	N/A	✓
-PM	PMI - Positive Material Identification Certificate	✓	✓	✓	✓	✓	✓	✓	✓	✓	✓	N/A	✓
-HT	Hydrostatic Test per ASME B31.3	✓	✓	✓	✓	✓	✓	✓	✓	✓	✓	N/A	N/A
-HL	Helium Leak Test Certificate	✓	✓	N/A	✓	✓	✓	✓	✓	✓	✓	N/A	N/A

✓ Indicates that the option is available
 N/A Indicates the option is not available

¹ Standard on MS8, available on MS4 & MS6.