

INDUSTRIAL STAINLESS/BRASS GAUGE

PRESSURE GAUGES

Reotemp's Series PG gauges are an economical choice where ambient corrosion and vibration are of concern. The stainless steel case and ring offer excellent corrosion resistance, and is fillable for applications with vibration. It is suitable for all fluids compatible with copper alloys.



Fillable



Custom Logo

FEATURES / BENEFITS

- Stainless Steel Case
- Copper Alloy Wetted Parts
- Field Fillable Case
- Convenient Panel Mounting Adapters



SPECIFICATIONS

Accuracy	2.5" = 3 - 2 - 3%, ASME Grade B 4" = 2 - 1 - 2%, ASME Grade A
Ambient Limits	-40°F/140°F
Process Limits	-40°F/140°F
Process Limits with Diaphragm Seal	Cannot be mounted to a diaphragm seal.
Wetted Materials	Tube: Copper Alloy Socket: Copper Alloy
Lens	Plastic (Standard) or Glass
Other Materials	Case: 304SS Ring: 304SS Dial: White Aluminum, Black Letters Case-to-Socket: Screw Connection
Fillable	Yes
Restrictor Screw	Built-in, Non-Removable
Maximum Working Pressure	Stable = 100% Momentary = 110% of scale
Environmental Protection	NEMA 4X/IP65
Weight	2.5" = 0.25 lbs (0.4 lbs filled) 4" = 0.6 lbs (1.2 lbs filled)

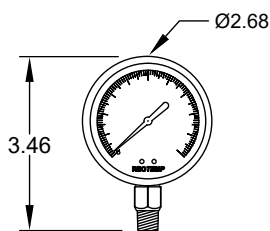

PG25C2

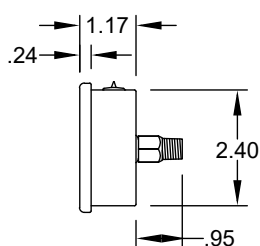

*dimensions in inches

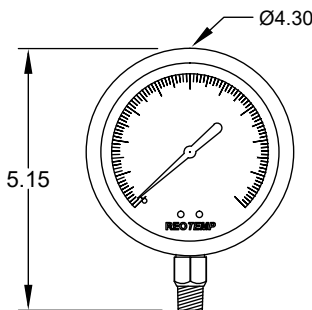

PG40C2

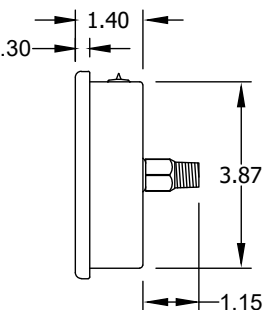

*dimensions in inches

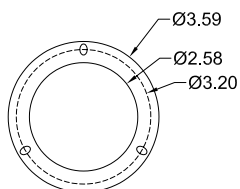

2.5" MOUNTING FLANGE

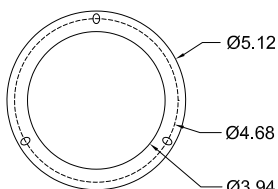

4" MOUNTING FLANGE





INDUSTRIAL STAINLESS/BRASS GAUGE



Visit reotemp.com

- ✓ Check Stock
- ✓ Get Price
- ✓ Configure Part #
- ✓ Download PDF Data Sheets

HOW TO ORDER: Choose options to build a part number. For example: **PG25C2A4P18-D-P-TS**

PG25	C	2	A	4	P18	-D	-P	-TS
DIAL SIZE	CASE TYPE	TUBE & SOCKET	MOUNT TYPE	CONNECTION	RANGE CODE	CASE FILL	LENS	OPTIONS
PG25 = 2.5" PG40 = 4"	C = 304SS Crimped Ring	2 = Copper Alloy	A =  Bottom B =  Bottom/Rear Flange C =  Center Back D =  Center Back "U" Clamp E =  Center Back/Front Flange	4 = 1/4" NPT *2 = 1/2" NPT	Common Ranges P16 = 0-30 psi P17 = 0-60 psi P18 = 0-100 psi P19 = 0-160 psi P20 = 0-200 psi P21 = 0-300 psi P23 = 0-600 psi P25 = 0-1,000 psi Available Ranges ■ Gauge Pressure, Vacuum, or Compound ■ Vac to 6,000 psi <i>For Additional Range Codes See Page 75</i>	-D = Dry -G = Glycerin -W = Glycerin/Water (65/35) <i>Note: This model cannot be filled with silicone.</i>	-P = Plastic *-G = Glass	-TS = Stainless Steel Tag <i>For Additional Options See Page 81</i>

*Non-standard configuration

PRESSURE GAUGE OPTIONS

Part #	Description	Heavy-Duty Industrial Gauges				Process Gauges			Stainless Steel Case Industrial Gauges			
		PR25	PR35	PR40	PR60	PT45P	PT45T	PI45	PM25/40	PM15/20	PG**C	PG**S
CASE FILL OPTIONS												
-G	Glycerin Filled Case	✓	✓	✓	✓	✓	✓	N/A	✓	✓	✓	✓
-W	Glycerin Water Filled Case (65/35)	✓	✓	✓	✓	✓	✓	N/A	✓	✓	✓	✓
-S	Silicone Filled Case	✓	✓	✓	✓	✓	✓	N/A	✓	✓	✓	✓
-T	Teflon-coated Movement (No Case Fill)	✓	✓	✓	✓	✓	✓	✓	✓	N/A	N/A	N/A
-I	Inert Case Fill	✓	✓	✓	✓	✓	✓	N/A	✓	N/A	N/A	N/A
LENS OPTIONS												
-P	Plastic Lens	STD	✓	✓	✓	✓	✓	STD	STD	STD	STD	✓
-T	Tempered Safety Glass Lens	✓	STD	STD	STD	STD	STD	N/A	N/A	N/A	N/A	STD
-S	Laminated Safety Glass Lens	✓	✓	✓	✓	✓	✓	N/A	✓	N/A	N/A	✓
-G	Plain Glass	N/A	N/A	N/A	N/A	N/A	N/A	N/A	MQ	MQ	MQ	N/A
POINTER OPTIONS												
-RP	Red Pointer	✓	✓	✓	✓	✓	✓	✓	✓	N/A	N/A	N/A
-MP	Min/Max Pointer (Drag Hand)†	✓	N/A	✓	✓	✓	✓	N/A	N/A	N/A	N/A	N/A
-MQ	Min/Max Pointer (Tamper-proof)†	✓	N/A	✓	✓	✓	✓	N/A	N/A	N/A	N/A	N/A
-RH	Red Set Hand (Manual Adjustment)	N/A	N/A	✓	✓	✓	✓	N/A	N/A	N/A	N/A	N/A
-EC	Electrical Contacts	N/A	N/A	✓	N/A	✓	N/A	N/A	N/A	N/A	N/A	N/A
DIAL OPTIONS												
-CL	Custom Logo Dial	✓	✓	✓	✓	✓	✓	✓	✓	MQ	MQ	✓
-HV	Hi-Vis Dial	✓	✓	✓	✓	✓	✓	✓	✓	✓	✓	✓
-CB	Color Band	✓	✓	✓	✓	✓	✓	✓	✓	MQ	MQ	✓
-CP	Color Pie	✓	✓	✓	✓	✓	✓	✓	✓	MQ	MQ	✓
-DM	Dial Marking	✓	✓	✓	✓	✓	✓	✓	✓	MQ	MQ	✓
-LP	Removable Lens Protector	N/A	N/A	N/A	N/A	✓	✓	✓	N/A	N/A	N/A	N/A
CALIBRATION OPTIONS												
-R1	Upgrade to 1% FS Accuracy	✓	✓	STD	STD	N/A	N/A	N/A	✓	N/A	N/A	✓
-R2	Upgrade to 0.5% FS Accuracy	N/A	N/A	✓	✓	STD	STD	STD	N/A	N/A	N/A	N/A
-R5	Upgrade to 1.5% FS Accuracy	✓	✓	N/A	N/A	N/A	N/A	N/A	✓	N/A	N/A	N/A
-C1	1pt. NIST Calibration Cert	✓	✓	✓	✓	✓	✓	✓	✓	✓	✓	✓
-C3	3pt. NIST Calibration Cert	✓	✓	✓	✓	✓	✓	✓	✓	✓	✓	✓
-C5	5pt. NIST Calibration Cert	✓	✓	✓	✓	✓	✓	✓	✓	✓	✓	✓
-CX	10pt. NIST Calibration Cert	✓	✓	✓	✓	✓	✓	✓	✓	✓	✓	✓
-CS	Calibration Sticker (No logged pts.)	✓	✓	✓	✓	✓	✓	✓	✓	✓	✓	✓
TAG OPTION												
-TS	Stainless Steel Tag (1-10 Characters)	✓	✓	✓	✓	✓	✓	✓	✓	✓	✓	✓
-TM	Stainless Steel Tag (11-80 characters)	✓	✓	✓	✓	✓	✓	✓	✓	✓	✓	✓
-TP	Paper Tag	✓	✓	✓	✓	✓	✓	✓	✓	✓	✓	✓
CERTIFICATION OPTIONS												
-CM	General Material Conformance	✓	✓	✓	✓	✓	✓	✓	✓	✓	✓	✓
-NC	Certificate of NACE Compliance	✓	✓	✓	✓	✓	✓	✓	N/A	N/A	N/A	N/A
-PM	Positive Material Identification Certificate (PMI)	✓	✓	✓	✓	✓	✓	✓	✓	✓	✓	✓
-HT	Hydrostatic Test per ASME B31.3 (5 min)	✓	✓	✓	✓	✓	✓	✓	✓	✓	✓	✓
-LC	Argon Leak Check Certificate	✓	✓	✓	✓	✓	✓	✓	✓	✓	✓	✓
CLEANING OPTIONS												
-DG	Degreased - Wiped Clean of Oils, Shipped in Sealed Bag	✓	✓	✓	✓	✓	✓	✓	✓	N/A	N/A	✓
-OX	Cleaned for Oxygen Service per ASME B40.1	✓	✓	✓	✓	✓	✓	✓	✓	MQ	MQ	✓
-OY	Cleaned for Oxygen Service per MIL-STD-1330D	✓	✓	✓	✓	✓	✓	✓	✓	N/A	N/A	✓
OTHER OPTIONS												
-NR	No Restrictor Screw	✓	✓	✓	✓	✓	✓	✓	✓	N/A	N/A	N/A

✓	Indicates that the option is available with the model.	N/A	Indicates the option is not available with this model.
STD	Indicates standard options with no additional cost.	MQ	Minimum order quantity applies.

†This option is only available with a plastic lens.

PRESSURE GAUGE RANGES AND CODES

PRESSURE GAUGES

VACUUM/COMPOUND RANGES

psi		Dual Scale & psi & Metric						Single Scale-Metric					
"Hg/0/psi		psi & bar		psi & kg/cm ²		psi & kPa		bar		kg/cm ²		kPa	
Code	Range	Code	Range	Code	Range	Code	Range	Code	Range	Code	Range	Code	Range
P01	-30"/Hg/0	D01	"Hg & -1/0 bar	G01	"Hg & -1/0 kg/cm ²	L01	"Hg & -100/0 kPa	B00	-1/0 bar	K00	-1/0 kg/cm ²	A00	-100/0 kPa
P02	-30/0/15	D02	psi & -1/0/1	G02	psi & -1/0/1	L02	psi & -100/0/100	B01	-1/0/1	K01	-1/0/1	A01	-100/0/100
P03	-30/0/30	D03	psi & -1/0/2	G03	psi & -1/0/2	L03	psi & -100/0/200	B02	-1/0/2	K02	-1/0/2	A02	-100/0/200
P04	-30/0/60	D04	psi & -1/0/4	G04	psi & -1/0/4	L04	psi & -100/0/400	B04	-1/0/4	K04	-1/0/4	A04	-100/0/400
P05	-30/0/100	D05	psi & -1/0/7	G05	psi & -1/0/7	L05	psi & -100/0/700	B07	-1/0/7	K07	-1/0/7	A07	-100/0/700
P06	-30/0/160	D06	psi & -1/0/11	G06	psi & -1/0/11	L06	psi & -100/0/1,100	B011	-1/0/11	K011	-1/0/11	A011	-100/0/1,100
P07	-30/0/200	D07	psi & -1/0/14	G07	psi & -1/0/14	L07	psi & -100/0/1,400	B014	-1/0/14	K014	-1/0/14	A014	-100/0/1,400
P08	-30/0/300	D08	psi & -1/0/20	G08	psi & -1/0/20	L08	psi & -100/0/2,000	B020	-1/0/20	K020	-1/0/20	A020	-100/0/2,000

PRESSURE RANGES

psi		Dual Scale & psi & Metric						Single Scale-Metric					
psi		psi & bar		psi & kg/cm ²		psi & kPa		bar		kg/cm ²		kPa	
Code	Range	Code	Range	Code	Range	Code	Range	Code	Range	Code	Range	Code	Range
P14	0-10 psi	D14	psi & .7 bar	G14	psi & .7 kg/cm ²	L14	psi & 70 kPa						
P15	0-15	D15	psi & 0-1	G15	psi & 0-1	L15	psi & 0-100	B1	0-1 bar	K1	0-1 kg/cm ²	A1	0-100 kPa
P16	0-30	D16	psi & 0-2	G16	psi & 0-2	L16	psi & 0-200	B2	0-2	K2	0-2	A2	0-200
P17	0-60	D17	psi & 0-4	G17	psi & 0-4	L17	psi & 0-400	B4	0-4	K4	0-4	A4	0-400
P18	0-100	D18	psi & 0-7	G18	psi & 0-7	L18	psi & 0-700	B7	0-7	K7	0-7	A7	0-700
P19	0-160	D19	psi & 0-11	G19	psi & 0-11	L19	psi & 0-1,100	B11	0-11	K11	0-11	A11	0-1,100
P20	0-200	D20	psi & 0-14	G20	psi & 0-14	L20	psi & 0-1,400	B14	0-14	K14	0-14	A14	0-1,400
P21	0-300	D21	psi & 0-20	G21	psi & 0-20	L21	psi & 0-2,000	B20	0-20	K20	0-20	A20	0-2,000
P22	0-400	D22	psi & 0-28	G22	psi & 0-28	L22	psi & 0-2,800	B28	0-28	K28	0-28	A28	0-2,800
P23	0-600	D23	psi & 0-40	G23	psi & 0-40	L23	psi & 0-4,000	B40	0-40	K40	0-40	A40	0-4,000
P24	0-800	D24	psi & 0-55	G24	psi & 0-55	L24	psi & 0-5,500	B55	0-55	K55	0-55	A55	0-5,500
P25	0-1,000	D25	psi & 0-70	G25	psi & 0-70	L25	psi & 0-7,000	B70	0-70	K70	0-70	A70	0-7,000
P30	0-1,500	D30	psi & 0-100	G30	psi & 0-100	L30	psi & 0-10,000	B100	0-100	K100	0-100	A100	0-10,000
P31	0-2,000	D31	psi & 0-140	G31	psi & 0-140	L31	psi & 0-14,000	B140	0-140	K140	0-140	A140	0-14,000
P32	0-3,000	D32	psi & 0-200	G32	psi & 0-200	L32	psi & 0-20,000	B200	0-200	K200	0-200	A200	0-20,000
P33	0-4,000	D33	psi & 0-280	G33	psi & 0-280	L33	psi & 0-28,000	B280	0-280	K280	0-280	A280	0-28,000
P34	0-5,000	D34	psi & 0-350	G34	psi & 0-350	L34	psi & 0-35,000	B350	0-350	K350	0-350	A350	0-35,000
P35	0-6,000	D35	psi & 0-400	G35	psi & 0-400	L35	psi & 0-40,000	B400	0-400	K400	0-400	A400	0-40,000
P36	0-8,000	D36	psi & 0-550	G36	psi & 0-550	L36	psi & 0-55,000	B550	0-550	K550	0-550	A550	0-55,000
P37	0-10,000	D37	psi & 0-700	G37	psi & 0-700	L37	psi & 0-70,000	B700	0-700	K700	0-700	A700	0-70,000
P38	0-15,000	D38	psi & 0-1,000	G38	psi & 0-1,000	L38	psi & 0-100,000	B1K	0-1,000	K1K	0-1,000	A1K	0-100,000
P39	0-20,000	D39	psi & 0-1,400	G39	psi & 0-1,400	L39	psi & 0-140,000						
P40	0-30,000	D40	psi & 0-2,000	G40	psi & 0-2,000	L40	psi & 0-200,000						
P41	0-40,000	D41	psi & 0-2,800	G41	psi & 0-2,800	L41	psi & 0-280,000						
P42	0-50,000	D42	psi & 0-3,500	G42	psi & 0-3,500	L42	psi & 0-350,000						



Don't See The Range You Need? Reotemp has thousands of specialty dial ranges available and will work with you to create a custom range, just contact Reotemp customer service.