

## INDUSTRIAL PRESSURE TRANSMITTER & SWITCH



Series TDS



Diaphragm Seal  
Compatible

### FEATURES / BENEFITS

- 0.25% Accuracy
- Display and Electrical Connection are Independently Rotatable 335°/343°
- Analogue Output Switchable 4-20mA or Voltage
- Rugged, with Protection from Shock, Over-range, and Over-voltage
- Calibration Range is Adjustable
- Excellent Long-term Stability

### SPECIFICATIONS

**Output Signal** 4-20mA, 3-Wire (Standard)  
0-5V, 0-10V, 1-6V (3-Wire)  
Switchable from 4-20mA to 0-10 VDC

**Measuring Principle** Thin-Film-On-Steel

**Pressure Ranges** Vacuum, Compound, Pressure to 7,500psi

	Proof Pressure	Burst Pressure
0/30 - 0/300 psi	3 x range	10 x range
0/500 - 0/7,500 psi	2.5 x range	4 x range

**Accuracy NLH at 77°F (BSL)** ±0.25% of span

**Input** 15-30 Vdc (4-20mA)  
15-30 Vdc (0-5V, 1-6V)  
15-30 Vdc (0-10V)

**Temperature** Effect: ±0.01% FS/°F (-13/185°F)  
Media: -13 to 185°F  
Ambient: -13 to 185°F

**Weight** Approximately 6.7 oz

**Environmental Rating** IP67

**Switching Output** 2 Transistors PNP

**Pressure Unit for Display** PSI, Bar, MPa, kPa, mWC, mmWC, %, User Scale

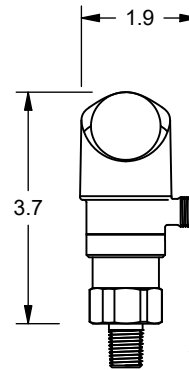

All dimensions are in inches.

Series TDS

Note: Dimensions are nominal and may vary. Check with REOTEMP sales if dimensions are critical. Other case styles available.

## INDUSTRIAL PRESSURE TRANSMITTER & SWITCH

**HOW TO ORDER:** Choose options to build a part number. For example: TDSP182AM5PVC03P14

TDS	P18	2	A	M500	P1	4
MODEL	RANGE	ACCURACY	OUTPUT SIGNAL	ELECTRICAL CONNECTION	PIN CONFIGURATION	PROCESS CONNECTION
TDS = Industrial Pressure Transmitter & Switch w/ Local Display	See Transmitter Technical Reference on pg. 240	2 = ±0.25% Full Scale	<p>A = 4-20mA (3-Wire) (Standard)</p> <p>B = 0-5Vdc (3-Wire)</p> <p>D = 1-6Vdc (3-Wire)</p> <p>E = 0-10Vdc (3-Wire)</p> <p>NOTE: Switching Output PNP for All Models</p>	<p>† M500 = M12 x1 (5-pin) (Standard)</p> <p>† *M00 = M12 x1 (4-pin)</p> <p>† M5PVC03 = M12 x1 Female (5-pin) w/ 3ft (1 Meter) PVC Shielded Cable</p> <p>† M5PVC10 = M12 x1(5-pin) Female w/ 10ft (3 Meter) PVC Shielded Cable</p> <p>† M5PVC33 = M12 x1 (5-pin) Female w/ 33ft (10 meter) PVC Shielded Cable</p> <p>† M5PVC?? = M12 x1 (5-pin), ?? ft. + PVC Shielded Cable</p> <p>† M5PUR05 = M12 x1(5-pin) Female w/ 5ft (1.5 Meter) PUR Shielded Cable</p> <p>† M5PUR?? = M12 x1 Female w/ ?? feet PUR Shielded Cable</p>	<p>P1 = 5-pin; 1: U+, 2: out, 3: U-, 4: SP1, 5: SP2 (standard)</p> <p>P2 = 5-pin; 1: U+, 2: SP2, 3: U-, 4: SP1, 5: out</p> <p>P3 = 4-pin; 1: U+, 2: out, 3: U-, 4: SP1</p>	<p>4 = 1/4" NPT Male (std)</p> <p>2 = 1/2" NPT Male</p> <p>F = 1/2" NPT Male Flush Face</p> <p>Diaphragm Seal (60 psi Minimum)</p>
				† Mating Connector Sold Separately.		

**-AD**

### OPTIONS

- AD = Adapter 1/2" NPT Male x 1/4" NPT Female 316SS, Rated to 3,000 psi. (PXAD24SS)
- RS = Threaded Restrictor Screw
- TS = Stainless Steel Tag (1-10 Characters)
- MC = M12x1 Female Connector, Field-Wireable
- PC = Protective Cap

*Optional Assembly to Diaphragm Seal Available*

TRANSMITTERS

## INDUSTRIAL PRESSURE TRANSMITTER &amp; SWITCH

## SPECIFICATIONS

## Parameters

Name	Standard Setting	Value Range	Short Name
Switch point SP1 (hysteresis mode) Upper switch point FH1 (window mode)	75% Measuring Range	SP1 > RP1 FH1 > FL1 Hysteresis $\geq 1\%$ FS	SP1
Reset point RP1 (hysteresis mode) Lower switch point FL1 (window mode)	25 % Measuring Range	RP1 < SP1 FL1 < FH1 Hysteresis $\geq 1\%$ FS	RP1
Switch point SP2 (hysteresis mode) Upper switch point FH2 (window mode)	75 % Measuring range	SP2 > RP2 FH2 > FL2 Hysteresis $\geq 1\%$ FS	SP2
Reset point RP2 (hysteresis mode) Lower switch point FL2 (window mode)	25 % Measuring range	RP2 < SP2 FL2 < FH2 Hysteresis $\geq 1\%$ FS	RP2
Switch point delay time SP1 (hysteresis mode) Switch point delay time FH1 (window mode)	0	0 ... 99.99 s	dS1
Switch point delay time RP1 (hysteresis mode) Switch point delay time FL1 (window mode)	0	0 ... 99.99 s	dR1
Switch point delay time SP2 (hysteresis mode) Switch point delay time FH2 (window mode)	0	0 ... 99.99 s	dS2
Switch point delay time RP2 (hysteresis mode) Switch point delay time FL2 (window mode)	0	0 ... 99.99 s	dR2
Functions switching output 1	Hysteresis, closer (Hno)	Hysteresis NO (Hno), Hysteresis NC (Hnc) Window NO (Fno), Window NC (Fnc)	ou1
Functions switching output 2	Hysteresis, closer (Hno)	Hysteresis NO (Hno), Hysteresis NC (Hnc) Window NO (Fno), Window NC (Fnc)	ou2
Pressure units	psi	bar, psi, MPa, kPa, m WC	uni
Measuring range adjustment	100 % Nominal pressure	50 ... 100 % Nominal	P-EP
Damping (analogue output)	0.01 s	0.01 ... 3.00 s (time constant)	dAA
Display rotation	No	no, yes (180°)	disr
Display mode	Current pressure value	Pressure value: current, highest, lowest, display off Current value: decimal places selectable (max. 3)	dis
Display actualisation	2	1, 2, 5, 20 Hz	duPd

## INDUSTRIAL PRESSURE TRANSMITTER & SWITCH

<b>Electrical Data</b>	Output / Supply voltage	4 ... 20 mA: 24 (15...30) VDC 0 ... 5 VDC: 24 (15...30) VDC 1 ... 6 VDC: 24 (15...30) VDC 0 ... 10 VDC: 24 (15...30) VDC
	Switch-on-delay	Typ. 200 ms
	Inverse-polarity protection, short-circuit strength @77°F during 5 min	Integrated
	Current consumption	≤ 30 mA
	<b>Environmental Conditions</b>	Media temp
	Ambient temp	-13°F to 185°F
	Protection <sup>1</sup>	IP67
	Humidity	Max. 95% relative
	Vibration	10g (10...2,000 Hz)
	Shock	50g / 3ms
<b>EMC Protection</b>	Emission	EN/IEC 61000-6-3
	Immunity	EN/IEC 61000-6-2
<b>Mechanical Data</b>	Sensor (wetted parts)	1.4542 (AISI630)
	Pressure connection (wetted parts)	1.4542 (AISI630)
	Sealing	FPM, NBR, EPDM
	Housing	Zinc based die-casting alloy, nickel plated display housing plastic
	Male electrical plug	See ordering information
	Weight	appr. 6.7oz
	Mounting Torque	15 to 20 Nm
	Housing Alignment	Display 335° rotatable, max. 2.5 Nm. Electrical connection 343° rotatable, max. 5 Nm

<sup>1</sup>See Electrical Connection

## INDUSTRIAL PRESSURE TRANSMITTER &amp; SWITCH

Analogue Output			
Output Signal	Switchable 4...20 mA or voltage		
Accuracy	TEB @ -13°F to 185°F	[% FS typ.]	± 1.75
	NLH @ 77°F (BSL)	[% FS typ.]	± 0.25
	TC zero point and span	[% FS /F typ.]	± 0.03
	Long Term Stability 1 year	[% FS typ.]	± 0.1
Current Limiting Output Signal	4 ... 20 mA: 25 mA (overload) 0 ... 10 VDC: < 40 mA (short-circuit)		
Damping (Rise Time)	0.01 ... 3.00 s / 10 ... 90 % Nominal pressure		
Zero Set; <sup>1)</sup> Offset Correction of Analogue Output and Display Indication	± 0.2 % FS		
Measuring Range Zero Point Adjustment (P_nP)	0 ... 50 % FS		
Measuring Range End Point Adjustment (P_EP)	50 ... 100 % FS		
Zero Point Adjustment Analogue Output (o_nP)	Voltage output: 0 ... 2 VDC Current output: 3.9 ... o_EP - 8 mA		
End Point Adjustment Analogue Output (o_EP)	Voltage output: o_nP + 4 ... 10.5 VDC Current output: o_nP + 8 ... 20.1 mA		
Switching Output			
Accuracy	NLH @ 41°F	[% FS typ.]	± 0.5
	TEB @ -13°F to 185°F	[% FS typ.]	± 1.0
	Long term stability 1 Year	[% FS typ.]	≤ ± 0.3
Adjustment Range of Switchpoints	0 ... 100 % FS		
Switching Hysteresis	≥ 1 % FS Switchpoint > reset point		
Switching Resistance	≤ 3 Ω		
Output Function	Hysteresis, Window; normally closed (NC), normally open (NO)		
Switching Current	≤ 0.5 A each switching output		
Current Limiting	≤ 2 A each switching output		
Switching Frequency	max. 200 Hz		
Delay Time	0 ... 99.99 s		
Display			
Display	4-digit 7-segment display 180° flippable with disable function Standard decimal places: ≤ 9: 3 decimal places 10 ... 99: 2 decimal places 100 ... 999: 1 decimal place		
Switching Status Indication	2 LED, red		
Operation	With 3 buttons and menu navigation according to VDMA 24574-1		
Display Resolution	0.1 % FS		
Display Range	-3 ... 103 % FS		
Setting Parameters	See table parameters		
User Scale Unit;	Display zero point: -999 ... 9998		
User Defined Values for Display Indication Zero Point and End Point	Display end point: -998 ... 9999		

## INDUSTRIAL PRESSURE TRANSMITTER & SWITCH

### TDS Dimensions

All dimensions are in inches.

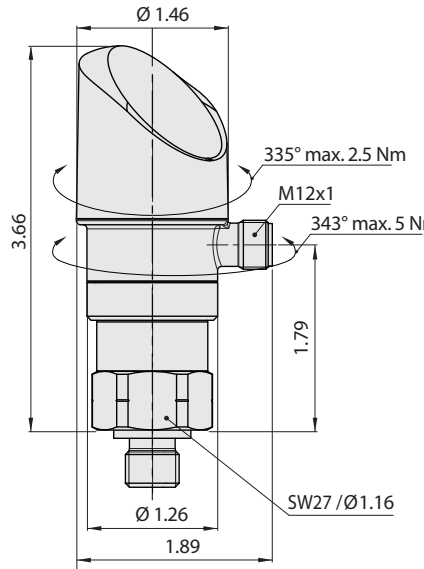

TDS

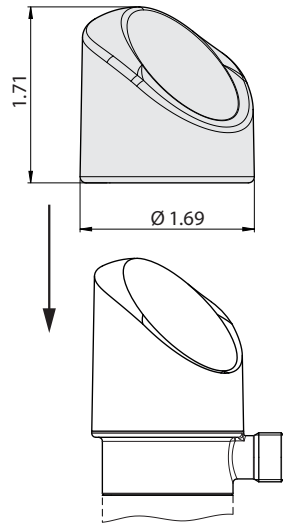

Protective cap

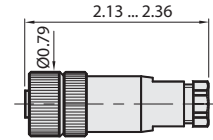

M12 Mating Connector

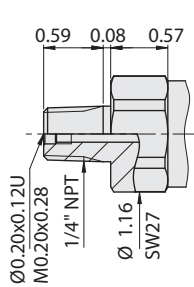

1/4" NPT

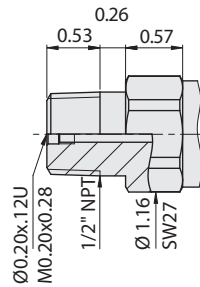

1/2" NPT

## INDUSTRIAL PRESSURE TRANSMITTER & SWITCH

### Electrical connection

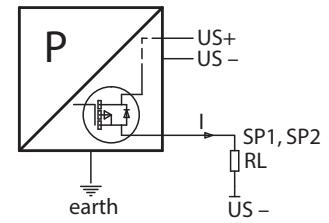
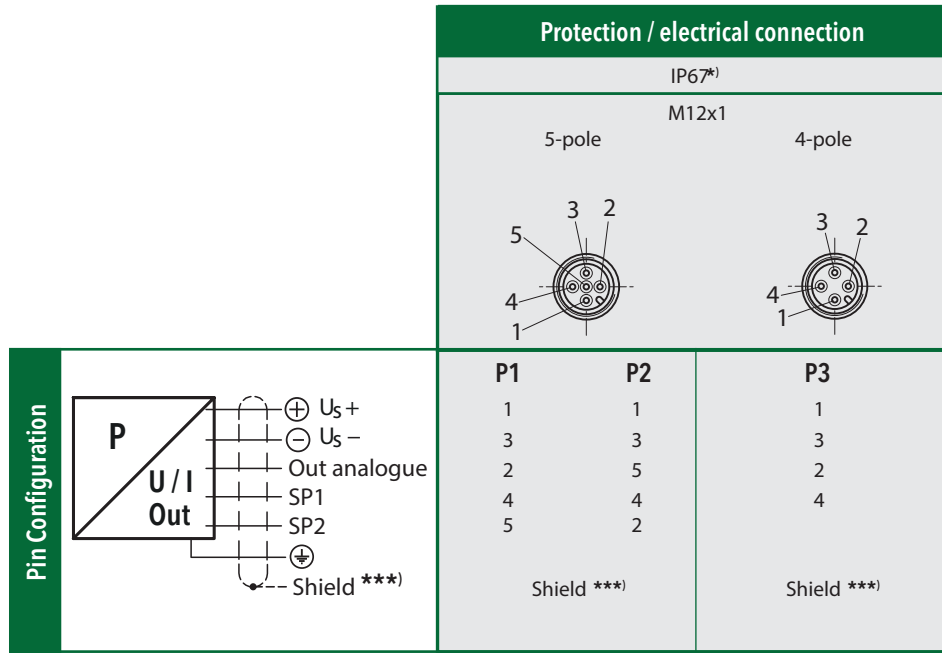

Connection of loads to switching output

\*) Provided female connector is mounted according to instructions

\*\*) The use of a shielded cable is recommended

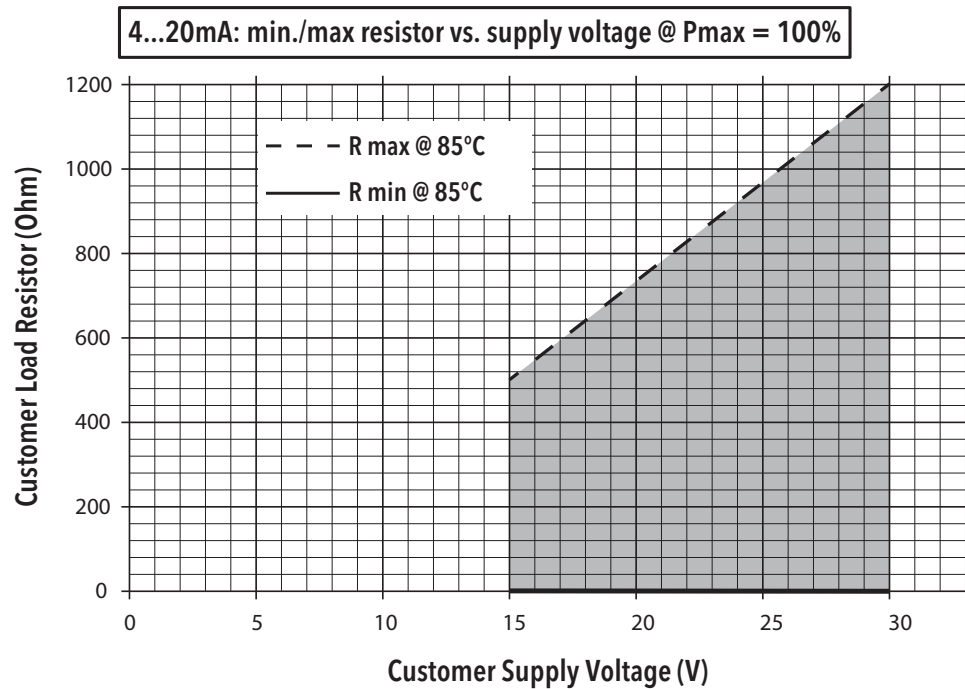

## INDUSTRIAL PRESSURE TRANSMITTER & SWITCH

### Functions switching output

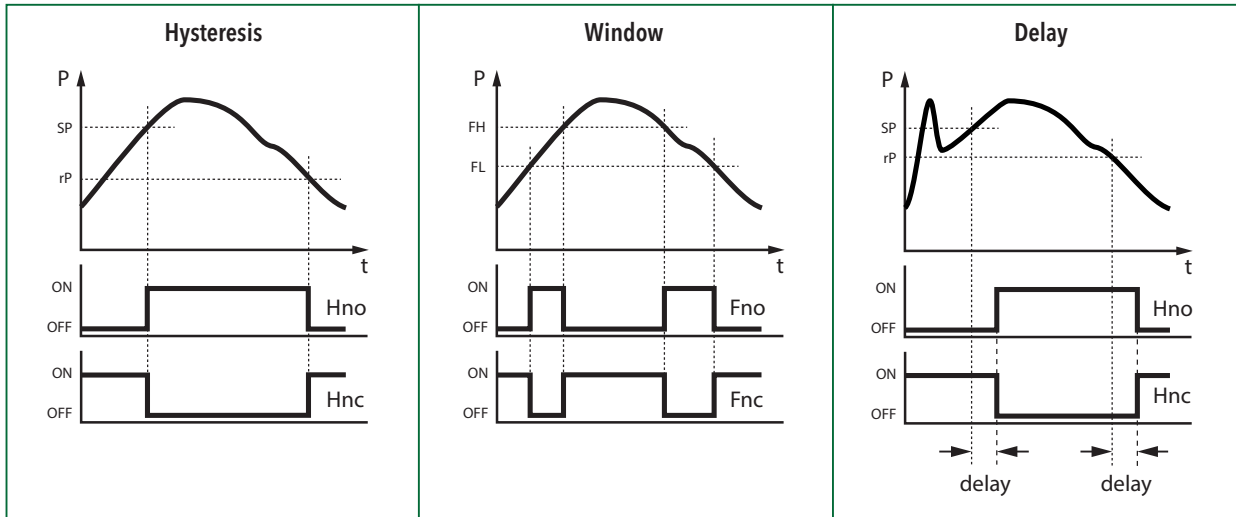



## TRANSMITTER TECHNICAL REFERENCE

SERIES		T90	TA	TSTA	TSA/ TSB	TSC	TSTP/ TSTD	TSTC	TG1	TP/ TDS	TC	TE	TH1	THX	TL1
Code		VACUUM													
P01	-30 inHg/0 psi	✓	✓	✓	✓	✓			✓			✓	✓	✓	
P01R	-14.5/0 psi							✓			✓				
Code		COMPOUND RANGES													
P02	-30 inHg/15psi	✓	✓	✓	✓	✓			✓				✓	✓	
P03	-30 inHg/30 psi	✓	✓	✓	✓	✓			✓			✓	✓		
P04	-30 inHg/60 psi	✓	✓	✓	✓	✓			✓						
P05	-30 inHg/100 psi	✓	✓	✓	✓	✓			✓			✓			
P06	-30 inHg/150 psi	✓	✓	✓	✓	✓			✓					✓	
P07	-30 inHg/200 psi	✓	✓	✓								✓			
P08	-30 inHg/300 psi	✓	✓	✓	✓	✓			✓						
P02R	-14.5/0/15 psi							✓			✓				
P03R	-14.5/0/30 psi						✓	✓		✓	✓				
P04R	-14.5/0/60 psi						✓	✓		✓	✓				
P05R	-14.5/0/100 psi						✓	✓		✓	✓				
P06R	-14.5/0/150 psi						✓	✓		✓	✓				
P07R	-14.5/0/200 psi						✓	✓		✓	✓				
P08R	-14.5/0/300 psi						✓	✓		✓	✓				
Code		PRESSURE RANGES													
IN50	0/50 inH <sub>2</sub> O	✓	✓	✓				✓			✓		✓		✓
IN100	0/100 inH <sub>2</sub> O	✓	✓	✓				✓	✓		✓		✓		✓
IN200	0/200 inH <sub>2</sub> O	✓	✓	✓				✓			✓				✓
L11	0/55 INWC	✓	✓	✓		✓		✓			✓		✓		
L12	0/80 INWC	✓	✓	✓		✓		✓			✓		✓		
L13	0/140 INWC	✓	✓	✓		✓		✓	✓		✓		✓		
L14	0/280 INWC	✓	✓	✓	✓	✓		✓	✓		✓		✓		
P11	0/2 psi	✓	✓	✓		✓		✓			✓		✓	✓	✓
P12	0/3 psi	✓	✓	✓		✓							✓	✓	✓
P13	0/5 psi	✓	✓	✓	✓	✓		✓	✓		✓		✓	✓	✓
P14	0/10 psi	✓	✓	✓	✓	✓		✓	✓		✓		✓	✓	✓
P15	0/15 psi	✓	✓	✓	✓	✓		✓	✓		✓	✓	✓	✓	✓
P16	0/30 psi	✓	✓	✓	✓	✓	✓	✓	✓	✓	✓	✓	✓	✓	✓
P175	0/50psi	✓	✓	✓			✓	✓		✓	✓				
P17	0/60 psi	✓	✓	✓	✓	✓			✓			✓	✓	✓	✓
P18	0/100 psi	✓	✓	✓	✓	✓	✓	✓	✓	✓	✓	✓	✓	✓	✓
P195	0/150 psi	✓	✓	✓	✓	✓	✓	✓	✓	✓	✓		✓	✓	✓
P20	0/200 psi	✓	✓	✓	✓	✓	✓	✓	✓	✓		✓	✓	✓	✓
P21	0/300 psi	✓	✓	✓	✓	✓	✓	✓	✓	✓		✓	✓	✓	✓
P26	0/500 psi	✓	✓	✓	✓	✓		✓	✓	✓	✓	✓	✓	✓	✓
P23	0/600 psi	✓	✓	✓	✓	✓			✓				✓		
P27	0/750 psi	✓	✓	✓	✓	✓			✓			✓	✓	✓	✓
P25	0/1000 psi	✓	✓	✓	✓	✓	✓		✓	✓		✓	✓	✓	✓
P30	0/1500 psi	✓	✓						✓	✓			✓		
P31	0/2000 psi	✓	✓						✓	✓			✓		
P32	0/3000 psi	✓	✓						✓	✓			✓		
P34	0/5000 psi	✓	✓						✓	✓			✓	✓	
P35	0/6000 psi	✓	✓						✓				✓		
P28	0/7500 psi	✓	✓						✓	✓			✓	✓	
P37	0/10000 psi	✓	✓						✓				✓	✓	
P38	0/15000 psi								✓				✓	✓	
P39	0/20000 psi												✓		
P40	0/30000 psi												✓		
P41	0/40000 psi												✓		
P42	0/50000 psi												✓		
P43	0/60000 psi												✓		
Code		ABSOLUTE RANGES													
P15A	0/15 psia		✓	✓	✓				✓		✓				
P16A	0/30 psia		✓	✓	✓				✓		✓				
P17A	0/60 psia		✓	✓	✓				✓		✓				
P18A	0/100 psia		✓	✓	✓				✓		✓				
P19A	0/150 psia		✓	✓	✓				✓		✓				
P20A	0/200 psia		✓	✓	✓				✓		✓				

TRANSMITTERS

**Don't See the Range You Need?**  
Other ranges may be available, contact REOTEMP customer service for more information.

✓ Indicates that the option is available  
Note: Specifications are subject to change.